

User Manual



EWS850AP
version 1.0

WiFi 6 AX1800 2x2 Dual Band Outdoor Wireless Access Point

IMPORTANT

To install this Access Point please refer to the **Quick Installation Guide** included in the product packaging.

Table of Contents

Chapter 1 Product Overview.....	4	Radius Accounting.....	38
Key Features/Introduction.....	5	Fast Roaming.....	39
System Requirements.....	7	Wireless MAC Filtering.....	40
Package Contents.....	7	Wireless Traffic Shaping.....	41
Technical Specifications.....	8	Management Interface.....	41
Physical Interface.....	10	Guest Network Settings.....	42
Chapter 2 Before You Begin.....	11	Management VLAN Setting.....	43
Computer Settings.....	12	Chapter 7 Mesh	44
Hardware Installation.....	16	Mesh Settings.....	41
Mounting the Device.....	17	Tools.....	46
Chapter 3 Configuring Your Access Point.....	19	Chapter 8 Management	47
Web Interface Configuration.....	20	Advanced Settings.....	48
EnWiFi App Configuration.....	21	CLI Settings/Email Alert.....	49/50
Chapter 4 Building a Wireless Network.....	22	Time Zone.....	51
Access Point	23	Auto Reboot Settings.....	52
WDS AP Mode.....	23	Wi-Fi Scheduler.....	53
WDS Bridge Mode.....	23	Tools.....	54
WDS Station Mode.....	25	Chapter 9 System Management	56
Chapter 5 Status.....	26	Account/Firmware.....	57
Main Status.....	27	Backup/Restore	58
Connection.....	29	Log.....	60
Realtime.....	30	Logout/Reset.....	61
Chapter 6 Network	31	Chapter 10 EnWiFi App	62
Basic IP Settings.....	32	About EnWiFi App.....	63
Spanning Tree Protocol Setting.....	32	Configuring Device in EnWiFi App.....	64
Wireless Settings.....	34	Appendix.....	75
Wireless Network.....	34	A-FCC Interference Statement.....	76
SSID Profile.....	36	B-Professional Installation Instruction (FCC).....	77
Wireless Security.....	37	C-IC Interference Statement.....	78
Radius Setting.....	38	D- Professional installation instruction (IC).....	80

Chapter 1

Product Overview



Overview

Key Features

- Dual concurrent 802.11ax architecture and backward compatible with ac wave2/ac/a/b/g/n client devices.
- Advanced 1024-QAM allows Access Points to carry more packets one time could work for delivering high speed rate than the legacy 11AC Access Points
- Bi-Directional (DL/UL) OFDMA utilizes air resource for Access Points and client devices efficiency.
- Bi-Directional (DL/UL) MU-MIMO will reduce usage of airtime for each transmission between Access Point and client devices.
- 360° omni-directional antennas to achieve comprehensive coverage for networking client devices under a pervasive environment.
- Power source is complied with 802.3at PoE Input for flexible installation and implementing remotely reset/reboot over 100 meters (328 feet).
- Robust housing with IP67 enclosure rated to deploy at extremely weather .
- Systemic and distributed management over EnGenius ezMaster, Skykey controller, and EWS Management switch without licensing or subscription fee.

Introduction

EnGenius Wireless Long Access Point solution EWS850AP is designed for deploying on the versatile indoor and outdoor application. To meet today's requirement on

varied networking environment, EnGenius would like to provide the solution as flexible, robust and effective as the organization they desire. The state-of-the-art OFDMA

Maximum data rates are based on IEEE 802.11 standards. Actual throughput and range may vary depending on many factors including environmental conditions, distance between devices, radio interference in the operating environment, and mix of devices in the network. Features and specifications subject to change without notice. Trademarks and registered trademarks are the property of their respective owners. For United States of America: Copyright © 2020 EnGenius Technologies, Inc. All rights reserved.



EWS850AP

and MU-MIMO technology brings revolutionary connecting speed and bandwidth for diversity of multimedia applications. EWS850AP 11ax solution engineers with powerful RF interfaces that support maximum 2x2 spatial streams with 1201 Mbps in 5GHz frequency band and 574 Mbps in 2.4GHz frequency band. With robust IP67 certified casing, these access points is designed to withstand harsh environment conditions including serve and prolonged exposure to sunlight, extreme cold, frost, snow, rainfall, hail and humidity.

DL/UL MU-MIMO with OFDMA via Beamforming

Be a prior AX solution, EnGenius EWS850AP is not only built in powerful RF interfaces, but it also features advanced Multi-Users Multiple input Multiple output (MU-MIMO) on both download side and upload side, which enhances a dramatic breakthrough in the performance and flexible transmission between Access Points and wireless client devices.

MU-MIMO allows multiple spatial streams to be allocated to different clients simultaneously, increasing totally throughput, reduce latency, capacity of the WLAN system and increase spectral efficiency on download side. Compared to download side, MU-MIMO upload side will manage varied

client devices to contest air resource within a channel under a pervasive environment. The MU-MIMO upload side coordinates with OFDMA upload side to arrange different types of traffic for using a proper bandwidth within a channel. The intelligent technology will carry multimedia content and web browsing data easily without consuming more time on round-trip between AP and client devices. The smoothly transmission will reduce collision times and enhance capacity of air resource, as well as optimize users experience.

Beamforming is a standard in 11ax which allows Access Points to focus energy of multiple antennas to transmit to a particular client device in that direction of that client. The innovative technology significantly enhances the higher signal-to-noise ratio and greater throughput of that client higher signal-to-noise ratio and greater throughput of that client. EnGenius

Enhance Capacity and Efficiency

Compared to 11ac solution, 11ax solution could carry 4x symbol OFDM symbol which can be significantly enhanced efficiency and transmitting PHY rate, as well as extend coverage on both indoor and outdoor application easily. To carry more data at the same time, modulation has been expanded from 11ac 256-QAM to 1024-QAM which can

be enhanced 25% capacity of bit and reduce error margin during delivering data. The other breakthrough innovation of 11ax is to introduced BSS coloring technology for marking different colors on each data which will allows client devices to stop

receiving a frame and return to sleep mode as soon as they recognize these frames are not of interest to them. The benefit of BSS coloring also reduces channel interference and channel collision of an access point, as well as improve to transmit signal easily.

System Requirements

The following are the Minimum System Requirements in order to configure the device.

- Computer with an Ethernet interface or wireless network capability
- Windows OS (XP, Vista, 7, 8, 10), Mac OS, or Linux-based operating systems
- Web-Browsing Application (i.e.: Internet Explorer, Firefox, Safari, or another similar browser application)

Package Contents

The package of EWS850AP contains the following items:*

- EWS850AP
- Detachable Antennas - 2.4GHz*2/ 5GHz*2
- PoE Adapter (EPA5006GR)
- Power Cord
- Pole Mount Strap*2
- Mountng Screw Set*2
- Mountng Bracket
- Ground Wire and Screw Set
- Quick Installation Guide

*(all items must be in package to issue a refund):

Technical Specifications

Standard

IEEE802.11 architecture and backward compatible with ac wave2/ ac/a/b/g/n client devices.

Antenna

External 2.4GHz*5dBi*2 and 5GHz*5dBi*2 detachable antenna

Physical Interface

1 x 2.5 Gigabit ethernet port supports 802.3at PoE Input

LED Indicator

Power

LAN

2.4GHz

5GHz

Power Requirements

EWS850AP Include 802.3at PoE Adapter

Operation Modes

Access Point

Mesh

WDS AP

WDS Bridge

WDS Station

Advance RF Management

OFDMA-UL/DL

BSS Coloring

Distance Control (Ack Timeout)

Multicast Supported

Data Rate Selection

Auto Channel Selection

Auto Tx Power Selection

Site Survey

Fast Roaming (802.11k/v)

Band Steering

RSSI Threshold

MU-MIMO-UL/DL

Tx Beamforming-UL/DL

Easily Management

VLAN Tag / VLAN Pass-through

Guest Network

QoS: Complaint with IEEE 802.11e /WMM

RADIUS Accounting

Wireless STA (Client) connection list

Traffic Shaping (Per SSID/User)

Multi SSID

Management VLAN

VLAN per SSID

E-mail Alerts

WiFi Scheduler

Intuitive Tools

SNMP v1/v2c/v3 support

MIB I/II, Private MIB

Save Configuration as Default

CLI Support

WiFi-Scheduler/Auto Reboot

E-mail Alert

Reinforcement Security

WPA3/WPA2 Personal/Enterprise

802.1x Authentication

Hide SSID in beacons

MAC address filtering, up to 32 MACs per SSID

Wireless STA (Client) connection list

Https Support

SSH Support

Optimal Performance

QoS-Compliant with IEEE 802.11e standard

Power Save Mode (UPASD)

Pre-Authentication

PMK Caching

Fast Roaming (802.11r)

Multicast to Unicast

1024-QAM both on 2.4GHz/5GHz

Physical/Environment Conditions

Operating:

Temperature: -20 °C to 60 °C (-4 °F to 140 °F)

Humidity (non-condensing): 90% or less

Storage:

Temperature: -30 °C to 80 °C (-22 °F to 176 °F)

Humidity (non-condensing): 90% or less

Physical Interface - EWS850AP

Mechanical & Environment

Length: 190 mm (7.48")

Width: 124 mm (4.88")

Depth: 47 mm (1.85")

Weight: 720g

*Above information is device Only

Protection Level: IP67

Surge Protection: 1KV

ESD Protection: Contact 4KV / Air 8KV

- 1 **2.4GHz Antennas** Detachable 5.17dBi 5GHz Omni-directional Antennas
- 2 **5GHz Antennas** Detachable 5.17dBi 2.4GHz Omni-directional Antennas
- 3 **LAN Port (802.3af/at PoE)**: Ethernet port for RJ-45 cable.
- 4 **LED Indicators**: LED lights for Power, LAN Port, 2.4 GHz Connection and 5 GHz Connection. The color of LED light and active behavior is as below.
- 5 **Mounting Holes**: Using the provided hardware, the AP can be attached to a wall or pole.

*The installation angle of antenna must be vertical to the ground.

*This equipment is not suitable for use in locations where children are likely to be present.

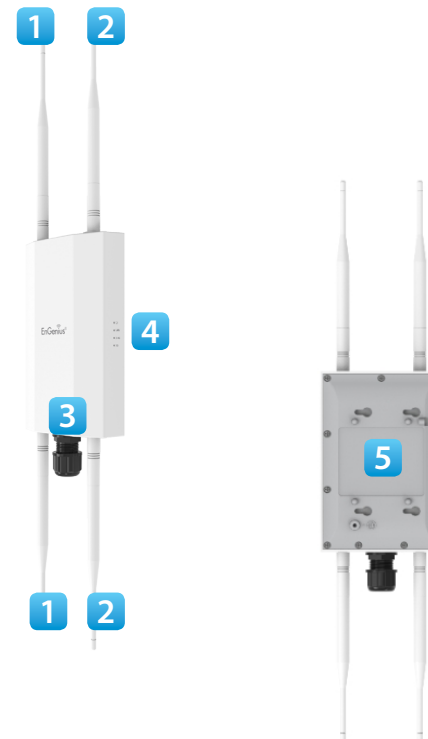

Chapter 2

Before You Begin



Computer Settings

Windows XP/Windows 7/Windows 8/Windows 10

In order to use the Access Point, you must first configure the TCP/IPv4 connection of your Windows OS computer system.

1a. Click the **Start** button and open the **Control Panel**

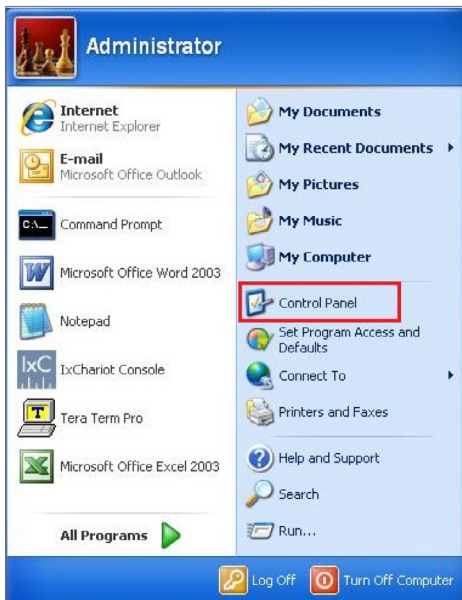

Windows XP

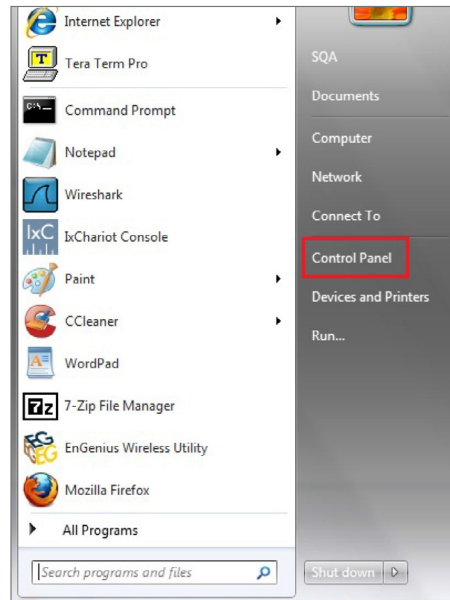

Windows 7

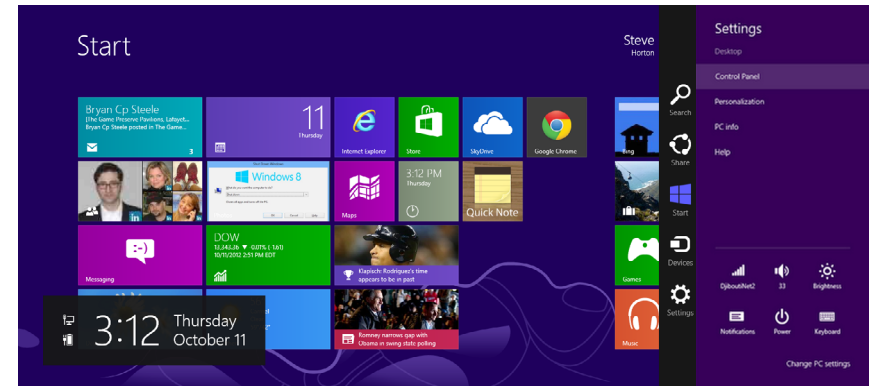

Windows 8

1c. In **Windows 10**, click **Start** to select **All APPs** to enter the folder of **Windows system** for selecting **Control Panel**.

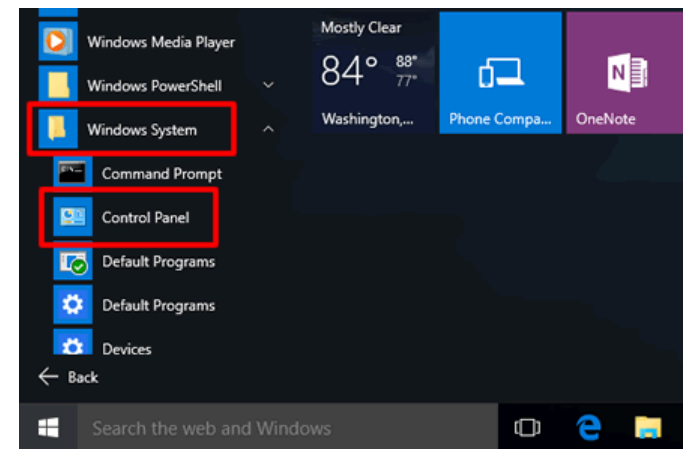

Windows 10

1b. Move your mouse to the lower right hot corner to display the Charms Bar and select the **Control Panel** in Windows 8 OS.

2a. In Windows XP, click **Network Connections**.



2b. In Windows 7/Windows 8/Windows 10, click **View Network Status and Tasks** in the **Network and Internet** section, then select **Change adapter settings**.

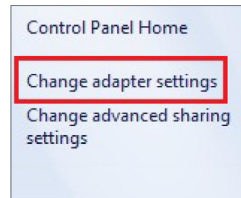
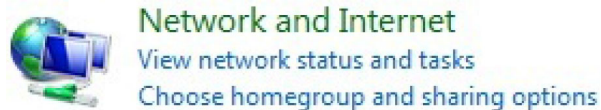

3. Right click on **Local Area Connection** and select **Properties**.

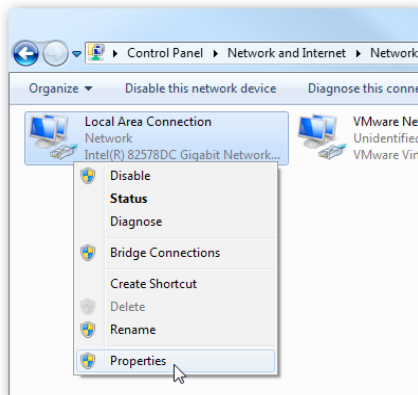

4. Select **Internet Protocol Version 4 (TCP/IPv4)** and then select **Properties**.

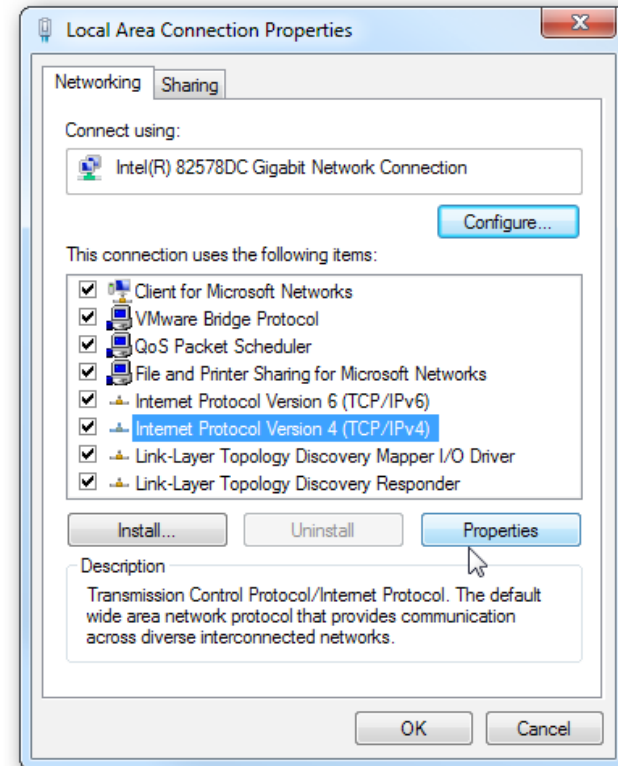

5. Select **Use the following IP address** and enter an IP address that is different from the Access Point and Subnet mask, then click **OK**.

Note: Ensure that the IP address and Subnet mask are on the same subnet as the device.

For example: EWS850AP IP address: 192.168.1.1

PC IP address: 192.168.1.2 - 192.168.1.255

PC Subnet mask: 255.255.255.0

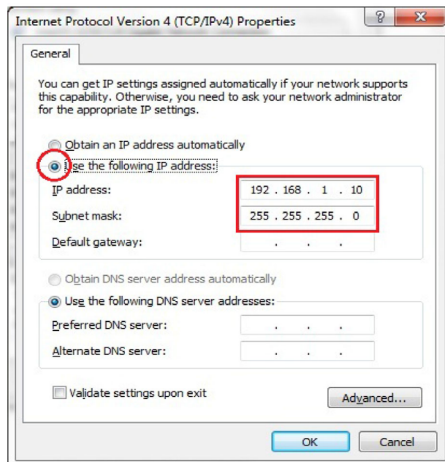

Apple Mac OS X

1. Go to **System Preferences** (which can be opened in the Applications folder or selecting it in the Apple Menu).
2. Select **Network** in the **Internet & Network** section.



3. Highlight **Ethernet**.
4. In **Configure IPv4**, select **Manually**.
5. Enter an IP address that is different from the Access Point and Subnet mask then press **OK**.

Note: Ensure that the IP address and Subnet mask are on the same subnet as the device.

For example: EWS850AP IP address: 192.168.1.1

PC IP address: 192.168.1.2 - 192.168.1.255

PC Subnet mask: 255.255.255.0

. Click **Apply** when done.

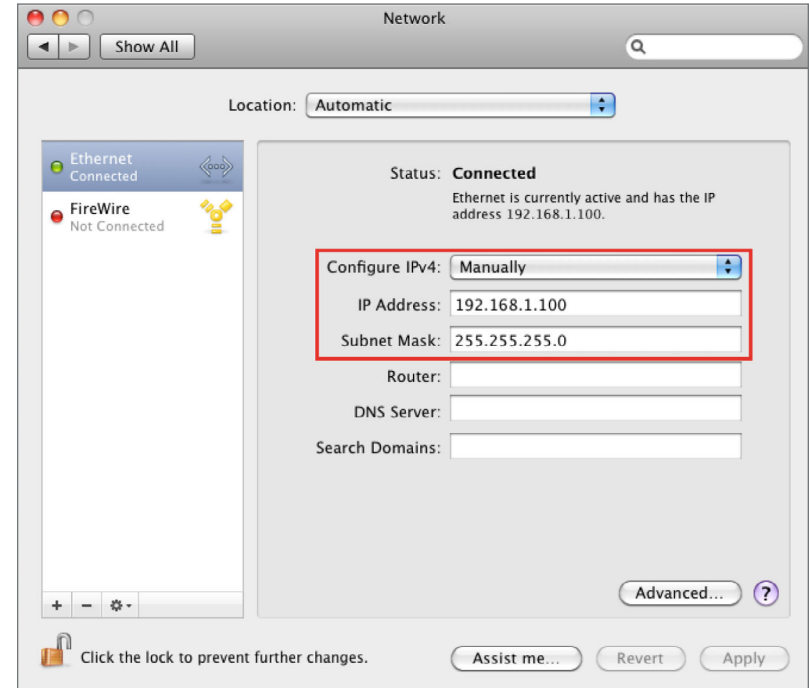

Hardware Installation

EWS850AP

1. Connect one end of the Ethernet cable into the LAN port (PoE) of the AP and the other end to the PoE port on the PoE adapter.
2. Connect the Power cord with the PoE Adapter and plug the other end into an electrical outlet.
3. Connect the second Ethernet cable into the LAN port of the PoE adapter and the other end to the Ethernet port on the computer.
4. Screw on the provided antennas to the top of this device
5. When all the process is completed, the LED light will be active as below.

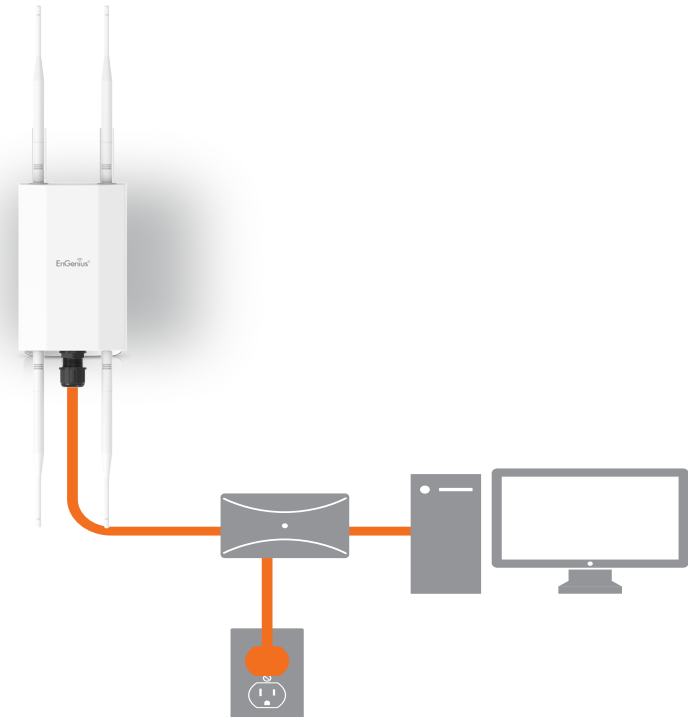

This diagram depicts the hardware configuration.

LED	State	Description
PWR  (ORANGE)	OFF	No power connection.
	On Steady	When the device is connected to a power source.
LAN (PoE) (Green/Amber)	OFF	No Ethernet connection.
	On Steady	An active Ethernet connection is made to the LAN (PoE) port.
2.4GHz (Green)	Blink	Data is being Transmitting/Receiving. The LED color indicates the Ethernet connection speed. Amber for 2.5Gbps and Green for 1Gbps or 100Mbps.
	On Steady	Ready for data Transmitting/Receiving.
5GHz (Green)	Blink	Data is being Transmitting/Receiving.
	On Steady	Ready for data Transmitting/Receiving.

Note: The AP should ONLY be powered via Ethernet cable connected to the included PoE Adapter EPA5006GR. You can convert the device to factory default or users default via the reset button on EPA5006GR.

Mounting the EWS850AP

Using the provided hardware, the device can be attached to a wall or a pole. The height should not exceed 2 meter.

1. Wall Mounting Kit

Screw Set 1

-Anchors: $\Phi 6.6 \times 16$ mm

-Bolts: $\Phi 8 \times 25$ mm

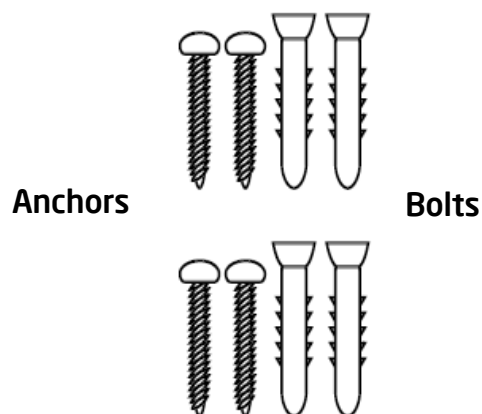

2. Pole Mounting Strap*2

- $\Phi 66 \times 12.6$ mm

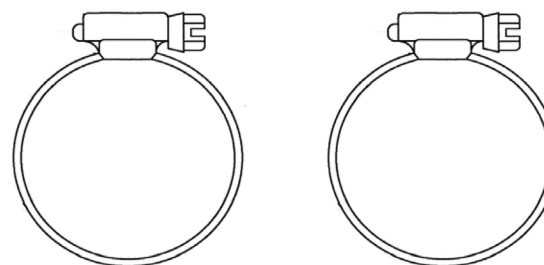

Screw Set 2

-Screw - X type: $\Phi 13 \times 42$ mm

-Screw - P type: $\Phi 5.8 \times 32$ mm

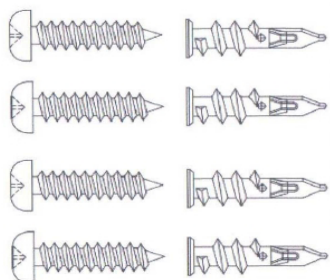

Wall mounting the EWS850AP

- A. Determine where the Access Point to be placed and mark location on the surface for the four mounting holes of wall mount base.
- B. Use the appropriate drill bit to drill two 8.1mm diameter and 26mm depth holes in the markings and hammer the bolts into the openings. Screw the anchors into the holes until they are flush with the wall.
- C. Screw the included screws into the anchors.
- D. Slide the mount bracket into the slot of the Access Point.

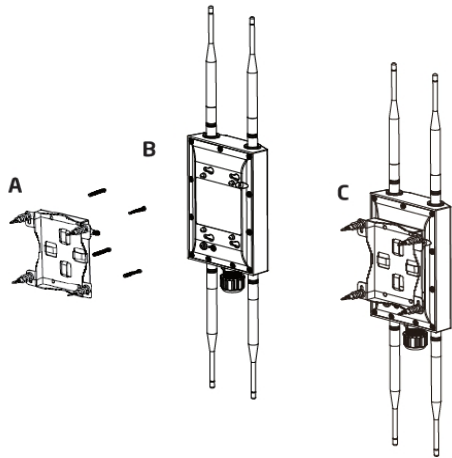

Pole mounting the EWS850AP

- A. Thread the open end of the Pole Strap through the two tabs on the Pole Mount Bracket.
- B. Lock and tighten Pole Strap to secure Pole Mount Bracket to the pole.

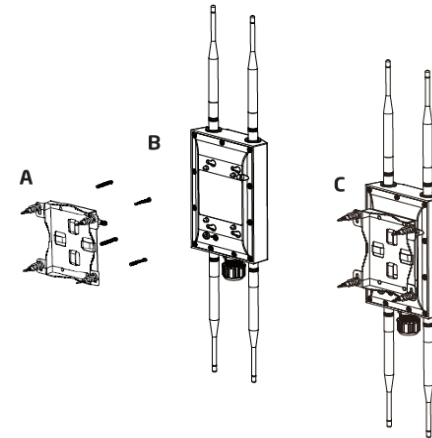

Chapter 3

Configuring Your Access Point



Configuring Your Access Point

This section will show you how to configure the device by using the web-based configuration interface or EnGenius EnWiFi App, which is a management tool to enable easy deployment on outdoor APs/CPEs. In conjunction with the EnWiFi App, outdoor APs/CPEs can perform configuration changes en-masse, monitoring, firmware upgrades, and data backups from a smart phone or tablet.

Web Interface Configuration

Default Setting

Please use your Ethernet port or wireless network adapter to connect the Access Point.

IP Address	192.168.1.1
Username / Password	admin / admin

1. Open a web browser (Internet Explorer/Firefox/Safari/Chrome) and enter the IP Address **http://192.168.1.1**

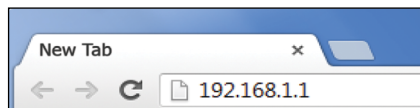

Note: If you have changed the default LAN IP Address of the Access Point, ensure you enter the correct IP Address.

2. The default username and password are **admin**. Once you have entered the correct username and password, click the **Login** button to open the web-base configuration page.

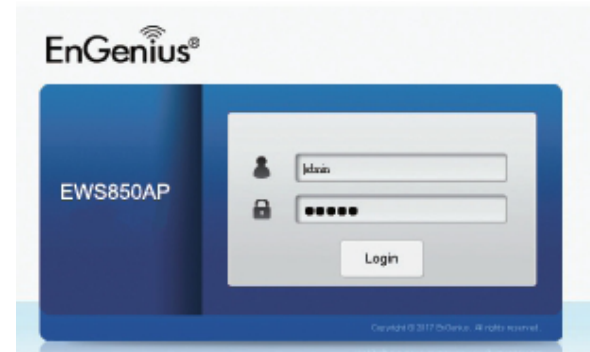

- * The model name will be varied by different models
3. If successful, you will be logged in and see the device's User Interface.

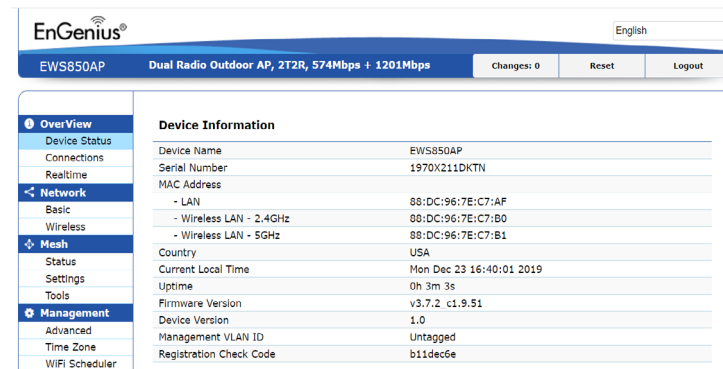

EnWiFi App Configuration

Download EnWiFi App

1. Please download and install EnWiFi App from Google Play or iOS App Market .



Android



iOS

2. Before access to device, you need to find Management SSID and connect to it first. Then you can see your device in the Device List.

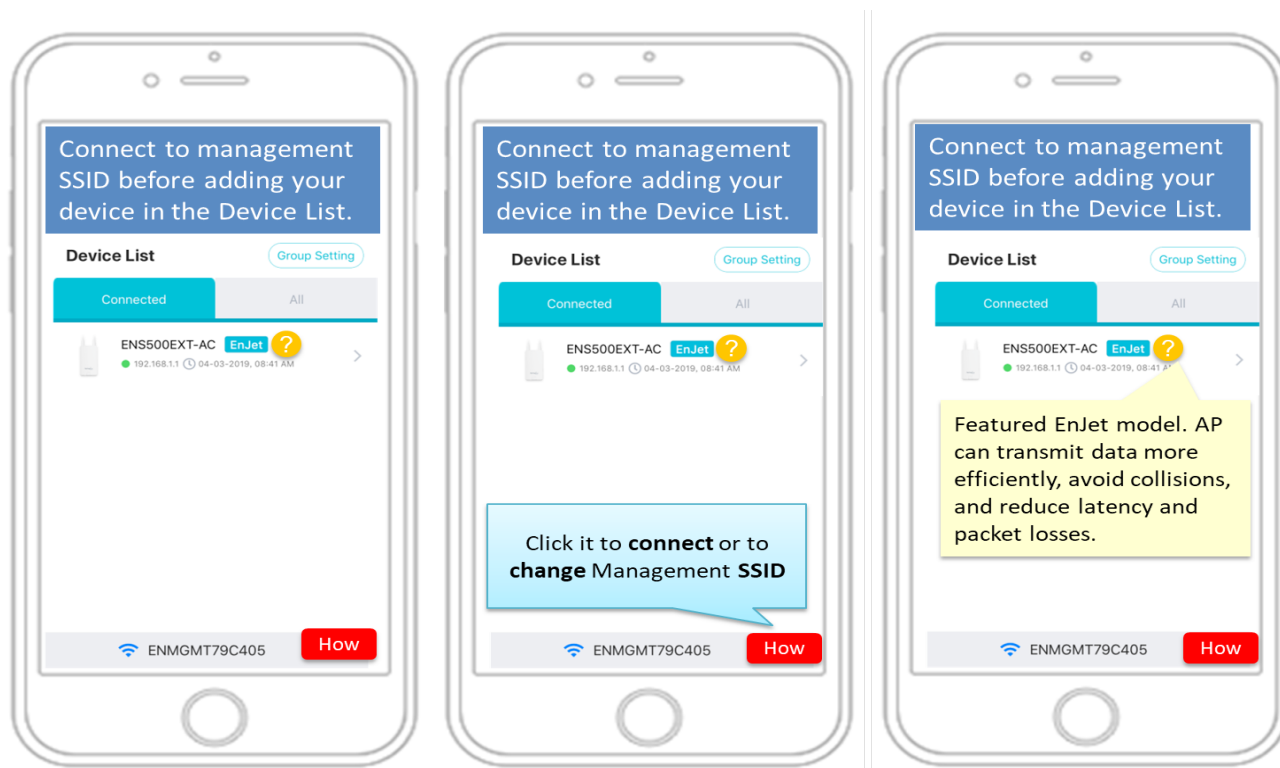

3. For more details of how to configure and management device via EnWiFi App, please see Chpater 9 EnWiFi App.

Chapter 4

Building a Wireless Network



Before Starting

Before starting to configure this Access Point, you may realize the used scenario under varied operating modes. EWS850AP, built in the latest WiFi 6 (11ax) technology, can be configured as an: Access Point, Mesh or WDS (AP/Bridge/Station). This chapter describes purpose of different operating modes for the best deployment.

Access Point Mode

In Access Point Mode, device behaves like a central connection for stations or clients that support IEEE 802.11ax networks and is backward compatible. The stations and clients must be configured to use the same SSID (Service Set Identifier) and security password to associate with EWS850AP. The device supports up to eight (8) SSIDs per band at the same time for secure access.

WDS AP Mode

The device also supports WDS AP mode. This operating mode allows wireless connect to the other device via using WDS technology. In this mode, configure the MAC addresses in both Access Points to enlarge the wireless area by enabling WDS Link settings. WDS supports up to four (4) AP MAC addresses.

WDS Bridge Mode

In WDS Bridge Mode, the device can wirelessly connect different LANs by configuring the MAC address and security settings of each device. Use this mode when two wired LANs located a small distance apart want to communicate with each other. The best solution is to use the device to wirelessly connect two wired LANs, as shown in the following diagram. WDS Bridge Mode can establish up to four WDS links, creating a star-like network.

Note: WDS Bridge Mode does not act as an Access Point. Access Points linked by WDS are using the same frequency channel. More Access Points connected together may lower throughput.

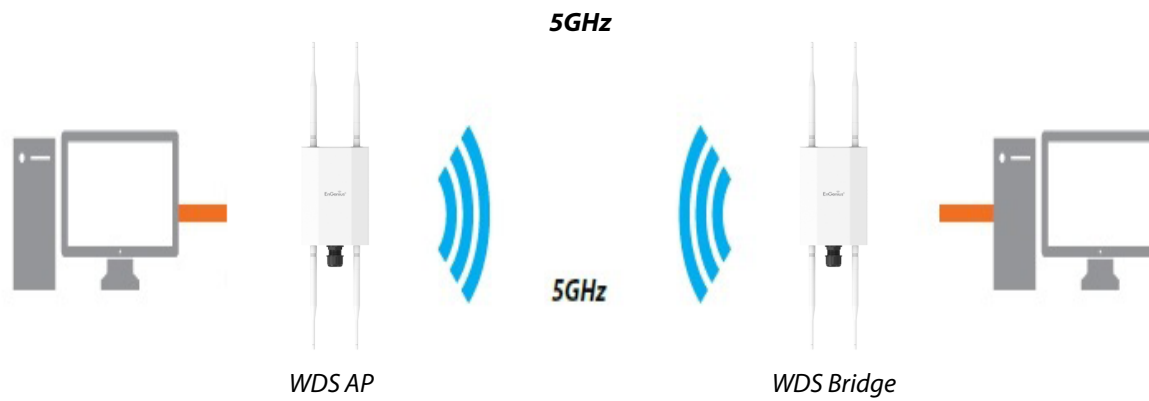

WDS Station Mode

Station mode expands the WDS by receiving a wireless signal/service and sharing it through the Ethernet port.

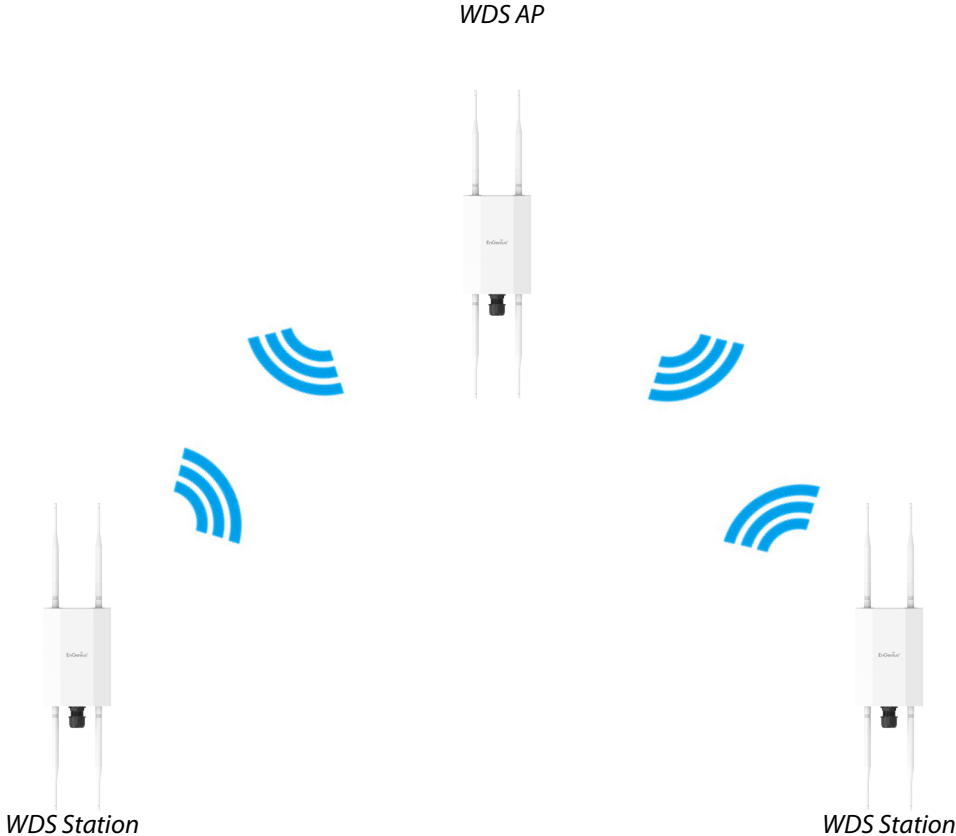

Chapter 5

Overview Status



Main Status

Save Changes

This page lets you save and apply the settings shown under **Unsaved changes list**, or cancel the unsaved changes and revert to the previous settings that were in effect.



*The model name will be varied by different models.

Device Status

Clicking the **Device Status** link under the **Overview** menu shows the status information about the current operating mode.

- The **Device Information** section shows general system information such as Device Name, MAC Address, Current Time, Firmware Version, and Management VLAN ID

Note: VLAN ID information is only applicable in Access Point or WDS AP mode.

Device Information

Device Name	EWS850AP
Serial Number	204242466
MAC Address	
- LAN	88:DC:96:88:7B:CC
- Wireless LAN - 2.4GHz	88:DC:96:88:7B:CD
- Wireless LAN - 5GHz	88:DC:96:88:7B:CE
Country	USA
Current Local Time	Thu Apr 23 10:21:41 2020
Uptime	0h 39m 54s
Firmware Version	v3.8.0_c1.9.51
Device Version	1.0
Management VLAN ID	Untagged
Registration Check Code	6f7e95c9

*The model name will be varied by different models.

- The **Memory Information** section shows usage of memory such as Total Available, Free, Cached, Buffered

Memory Information

Total Available	702564 kB / 910188 kB (77%)
Free	642436 kB / 910188 kB (70%)
Cached	45800 kB / 910188 kB (5%)
Buffered	14328 kB / 910188 kB (1%)

- The **LAN Information** section shows the Local Area Network settings such as the LAN IP Address, Subnet mask, and DNS Address.

LAN Information - IPv4	
IP Address	192.168.1.1
Subnet Mask	255.255.255.0
Gateway	N/A
Primary DNS	N/A
Secondary DNS	N/A
DHCP Client	Enable
Spanning Tree Protocol(STP)	Disable
LAN Information - IPv6	
IP Address	N/A
Link-Local Address	fe80::8adc:96ff:fe88:7bcc
Gateway	N/A
Primary DNS	N/A
Secondary DNS	N/A

- The **Wireless LAN Information 2.4GHz/5GHz** section shows wireless information such as Operating Mode, Frequency, and Channel. Since the AP supports multiple-SSIDs, information about each SSID, the ESSID, and security settings, are displayed

Note: Profile Settings are only applicable in Access Point and WDS AP modes.

Wireless LAN Information - 2.4GHz	
Operation Mode	Access Point
Wireless Mode	802.11 n/g/b
Channel Bandwidth	20 MHz
Channel	2.412 GHz(Channel 1)
Distance	1000 M
Wireless LAN Information - 5GHz	
Operation Mode	Access Point
Wireless Mode	802.11 ax/ac/n/a
Channel Bandwidth	80 MHz
Channel	5.640 GHz(Channel 128)
Distance	1000 M

- The **Statistics** section shows Mac information such as SSID, MAC address, RX and TX.

Statistics - Access Point 2.4GHz/5GHz						
Profile	SSID	Security	VID	802.1Q	RX(Packets)	TX(Packets)
#1	EnGenius887BCD_1	None	-	Disable	0.00 B(0 Pkts.)	0.00 B(0 Pkts.)
#2	ENMGMT887BCD	WPA2-Personal	-	Disable	0.00 B(0 Pkts.)	0.00 B(0 Pkts.)

Connection

2.4GHz/ 5GHz Connection List

Click the connection link under the Overview menu displays the connection list of clients associated to the AP/CPE's 5 GHz, along with the MAC addresses and signal strength for each client. Clicking **Refresh** updates the client list.

Note: Only applicable in Access Point and WDS AP modes.

WDS Link List

Click the connection link under the Overview menu. This page displays the current status of the WDS link, including WDS Link ID, MAC Address, Link Status and RSSI.

Note: Only applicable in WDS AP and WDS Bridge modes.

The screenshot shows a web interface with a left-hand navigation menu and a main content area. The navigation menu includes: Overview (selected), Device Status, Connections, Realtime, Network (with a left arrow), Basic, Wireless, Mesh (with a right arrow), Status, Settings, Tools, Management (with a gear icon), Advanced, Time Zone, WiFi Scheduler, and Tools. The main content area is titled 'Connection List - 2.4GHz' and contains a table with columns: SSID, MAC Address, TX (KB), RX (KB), RSSI (dBm), and Block. Below this table is another section titled 'Connection List - 5GHz' with the same column headers. A blue 'Refresh' button is located below the 5GHz table.

Realtime

The Realtime section contains the following options:

CPU Loading: 3 minutes CPU loading percentage information, it displays current loading, average loading and peak loading status. Left bar is loading percentage; button is time tracing. The interval is every 3 seconds.

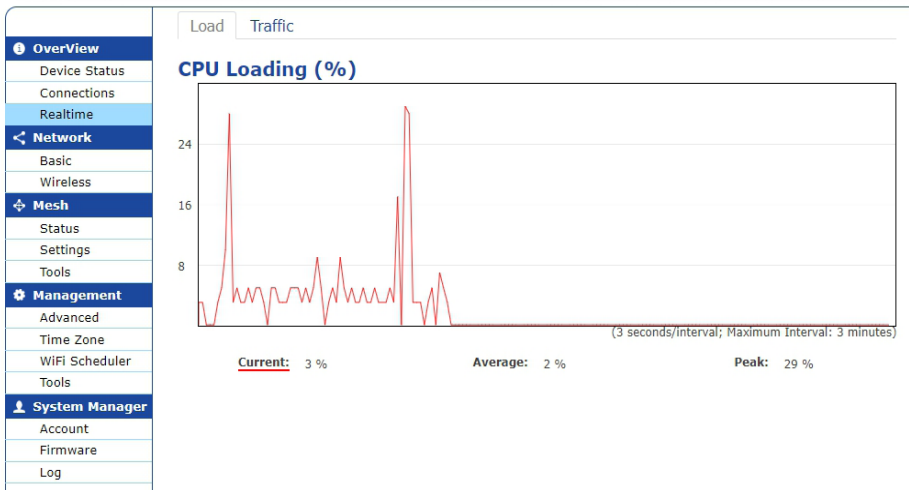

Traffic Loading: 2.4GHz/5GHz and Ethernet port inbound and outbound traffic by current, average and peak time.

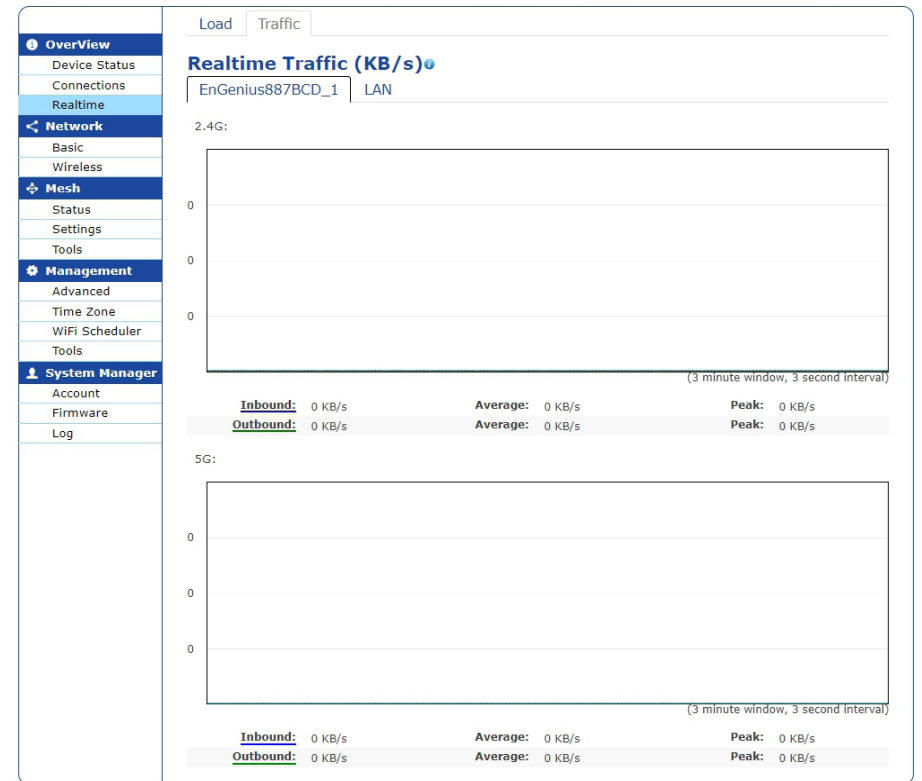

Chapter 6

Network



Basic IP Settings

IPv4/IPv6 Settings

This page allows you to modify the device's IP settings under Network->Basic.

IPv4 Settings	
IP Network Setting	Static IP ▾
IP Address	192.168.1.1
Subnet Mask	255.255.255.0
Gateway	192.168.1.1
Primary DNS	0.0.0.0
Secondary DNS	0.0.0.0
IPv6 Settings	<input checked="" type="checkbox"/> Link-local Address
IP Address	
Subnet Prefix Length	
Gateway	
Primary DNS	
Secondary DNS	

IP Network Settings: Select whether the device IP address will use a static IP address specified in the IP address field or be obtained automatically when the device connects to a DHCP server.

IP Address: The IP address of this device.

Subnet Mask: The IP Subnet mask of this device.

Gateway: The Default Gateway of this device. Leave it blank if you are unsure of this setting.

Primary/Secondary DNS: The primary/secondary DNS address for this device.

Save: Click **Save** to confirm the changes.

Spanning Tree Protocol (STP) Settings

This page allows you to modify the Spanning Tree settings. Enabling the Spanning Tree protocol will prevent network loops in your LAN network.

Spanning Tree Protocol (STP) Settings		
Status	Disable ▾	
Hello Time	2	seconds (1-10)
Max Age	20	seconds (6-40)
Forward Delay	4	seconds (4-30)
Priority	32768	(0-65535)

Spanning Tree Status: Enables or disables the Spanning Tree function.

Hello Time: Specifies Bridge Hello Time in seconds. This value determines how often the device sends handshake packets to communicate information about the topology throughout the entire Bridged Local Area Network.

Max Age: Specifies Bridge Max Age in seconds. If another bridge in the spanning tree does not send a hello packet for a long period of time, it is assumed to be inactive.

Forward Delay: Specifies Bridge Forward Delay in seconds. Forwarding delay time is the time spent in each of the Listening and Learning states before the Forwarding state

is entered. This delay is provided so that when a new bridge comes onto a busy network, it analyzes data traffic before participating in the network.

Priority: Specifies the Priority Number. A smaller number has a greater priority than a larger number.

Save: Click **Save** to confirm the changes.

Wireless

Wireless Settings

Wireless Settings	
Device Name	EWS850AP
Country / Region	USA

*The model name will be varied by different models.

Device Name: Enter a name for the device. The name you type appears in SNMP management. This name is not the SSID and is not broadcast to other devices.

Save: Click **Save** to confirm the changes.

This page displays the current status of the Wireless settings of the AP.

Wireless Network

EWS850AP supports 802.11ax/ac/n/a mixed mode in 5 GHz and 802.11n/g/b mixed mode in 2.4GHz. 802.11ax mode in 2.4GHz is optional and can be enabled/disabled. .

Operation Mode: Select **Operation Mode** from Access Point or WDS (AP, Bridge ,Station) base on the application scenario.

Channel HT Mode: The default channel bandwidth is 20 MHz in 2.4GHz and 80MHz in 5GHz. The larger the channel, the greater the transmission quality and speed.

Channel: Click Configuration button to open a new windows to configure channels for performing wireless service.

	2.4GHz (n/g/b)	5GHz (ax/ac/n/a)
Operation Mode	Access Point <input type="checkbox"/> Green	Access Point <input type="checkbox"/> Green
Channel HT Mode	20MHz	80MHz
Channel	Configuration	
Transmit Power	8 dBm	8 dBm
Bit Rate	Configuration	
Client Limits	Enable <input checked="" type="radio"/> Disable <input type="radio"/> 127	Enable <input checked="" type="radio"/> Disable <input type="radio"/> 127
Multicast to Unicast Stream Conversion	Enable <input checked="" type="radio"/> Disable <input type="radio"/>	
AP Detection	Scan	Scan
11ax mode	Enable <input type="radio"/> Disable <input checked="" type="radio"/>	
Distance (0-30km)	1 (0.6miles)	1 (0.6miles)

2.4GHz		5GHz	
All	None	All	None
1,6,11	1,4,8,11	U-NII-1	U-NII-2A
1,7	1,5,9	U-NII-2B	U-NII-3
Ch 1 : 2.412 GHz	Ch 2 : 2.417 GHz	Ch 36 : 5.180 GHz	Ch 40 : 5.200 GHz
Ch 3 : 2.422 GHz	Ch 4 : 2.427 GHz	Ch 44 : 5.220 GHz	Ch 48 : 5.240 GHz
Ch 5 : 2.432 GHz	Ch 6 : 2.437 GHz	Ch 52 : 5.260 GHz	Ch 56 : 5.280 GHz
Ch 7 : 2.442 GHz	Ch 8 : 2.447 GHz	Ch 60 : 5.300 GHz	Ch 64 : 5.320 GHz
Ch 9 : 2.452 GHz	Ch 10 : 2.457 GHz	Ch 100 : 5.500 GHz	Ch 104 : 5.520 GHz
Ch 11 : 2.462 GHz		Ch 108 : 5.540 GHz	Ch 112 : 5.560 GHz
		Ch 116 : 5.580 GHz	Ch 120 : 5.600 GHz
		Ch 124 : 5.620 GHz	Ch 128 : 5.640 GHz
		Ch 149 : 5.745 GHz	Ch 153 : 5.765 GHz
		Ch 157 : 5.785 GHz	Ch 161 : 5.805 GHz

Save Save current setting(s)

Transmit Power: Set the power output of the wireless signal.

Bit Rate: 2.4GHz and 5GHz can be controlled by BAR via scroll from 6Mbps to 54Mbps.

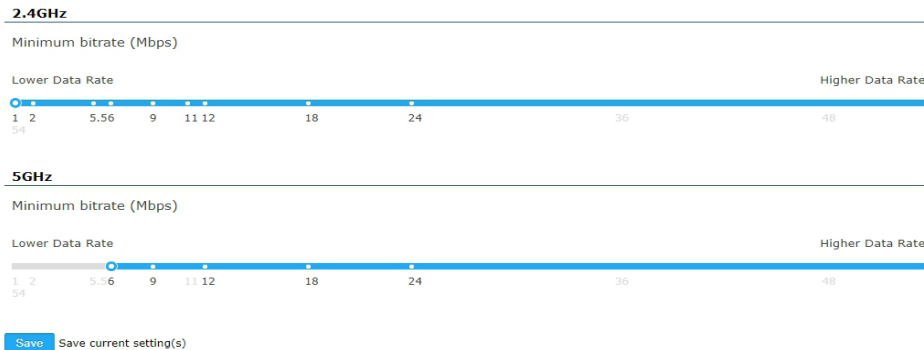

Client Limits	<input checked="" type="radio"/> Enable <input type="radio"/> Disable	<input checked="" type="radio"/> Enable <input type="radio"/> Disable
	<input type="text" value="127"/>	<input type="text" value="127"/>
Multicast to Unicast Stream Conversion	<input checked="" type="radio"/> Enable <input type="radio"/> Disable	<input checked="" type="radio"/> Enable <input type="radio"/> Disable
AP Detection	<input type="button" value="Scan"/>	<input type="button" value="Scan"/>
11ax mode	<input checked="" type="radio"/> Enable <input type="radio"/> Disable	
Distance (0-30km)	<input type="text" value="1"/> (0.6miles)	<input type="text" value="1"/> (0.6miles)

Client Limits: If you set the limitation of client numbers, the maximum associated client devices will be restricted at this number. The client limits is default in 127.

AP Detection: AP Detection can select the best channel to use by scanning nearby areas for Access Points.

11ax mode: This mode is optional for 2.4GHz, you can select Enable or Disable based on the application scenario.

Distance: Specifies the distance between Access Points and client devices. The proper setting for this parameter may assist Access Points to avoid the improper operation when transmitting data under a filed application.

SSID Profile

Current Profile: You can configure up to eight(8)different SSIDs. If multiple client devices will be accessing the network, you can arrange the devices into SSID groups. Click **Edit** to configure the profile and check whether you want to enable extra SSID.

Wireless Settings - Access Point					
Enabled	SSID	Edit	Security	Guest Network	VLAN ID
<input checked="" type="checkbox"/>	EnGenius79C393_1	Edit	None	<input type="checkbox"/>	-
<input checked="" type="checkbox"/>	EnGenius79C393_2	Edit	None	<input type="checkbox"/>	-
<input checked="" type="checkbox"/>	EnGenius79C393_3	Edit	None	<input type="checkbox"/>	-
<input checked="" type="checkbox"/>	EnGenius79C393_4	Edit	None	<input type="checkbox"/>	-
<input checked="" type="checkbox"/>	EnGenius79C393_5	Edit	None	<input type="checkbox"/>	-
<input checked="" type="checkbox"/>	EnGenius79C393_6	Edit	None	<input type="checkbox"/>	-
<input checked="" type="checkbox"/>	EnGenius79C393_7	Edit	None	<input type="checkbox"/>	-
<input checked="" type="checkbox"/>	EnGenius79C393_8	Edit	None	<input type="checkbox"/>	-

The first SSID is default enabled and you can click Edit to specify the detail setting, including:

Enable: Click the check box to enable specific SSID interface. The first SSID is default enabled.

SSID: Specifies the SSID name for the current profile.

Hidden SSID: Check this option to hide the SSID from clients. If checked, the SSID will not appear in the site survey.

Client Isolation: Block the communication between the associated clients under the same WLAN.

VLAN Isolation: When this function is checked with specified VLAN ID in a SSID profile, the traffic from this SSID will be tagged with this VLAN ID upon entering LAN bridge.

VLAN ID: Specifies the VLAN tag for each profile. If your network includes VLANs, you can specify a VLAN ID for packets pass through the Access Point with a tag.

L2 Isolation: Enable this function prevent client devices

Wireless Setting - Access Point 2.4GHz/5GHz

Enable 2.4G 5G

SSID

Hidden SSID Enable Disable

Client Isolation Enable Disable

VLAN Isolation Enable Disable
ID: (1~4094)

L2 Isolation Enable Disable

Band Steering: Enable this function to facilitate effective spectrum usage. 5GHz-capable clients can associate with AP's 5GHz radio and offloading air utilization in 2.4GHz

Band Steering

Status Enable Disable

Band Steering

5GHz RSSI dBm

Wireless Security

The Wireless Security section lets you configure the AP's security modes

Group Key Update Interval: Specifies how often, in seconds, the Group Key changes. The default value is 3600.

Wireless Security	
Security Mode	None ▼
Radius Settings	
<input type="checkbox"/> NAS-ID	None
<input type="checkbox"/> NAS-PORT	OWE
<input type="checkbox"/> NAS-IP	WPA2-Personal (0 ~ 65535)
Radius Accounting	
Radius Accounting	WPA3-Personal
Radius Accounting Server	WPA2/WPA3-Personal
Radius Accounting Port	WPA2-Enterprise
Radius Accounting Secret	WPA2/WPA3-Enterprise
Interim Accounting Interval	WPA3-Enterprise
	600

Wireless Security	
Security Mode	WPA2-Enterprise ▼
Encryption	AES ▼
Group Key Update Interval	3600 (30~3600; 0:Disable)
Radius Server	192.165.100.36
Radius Port	1812
Radius Secret	1234567890123456789012345

Security Mode: Including OWE, WPA2-Personal, WPA3-Personal, WPA2/WPA3-Personal, WPA2-Enterprise, WPA3-Enterprise, WPA2/WPA3-Enterprise. The following is an example for WPA2-Enterprise (Pre-Shared Key).

Encryption: Default is AES. Please ensure that your wireless clients use the same settings.

Note: 802.11n does not allow WPA2-PSK TKIP security mode.

Radius Settings

NAS-IP: Configure you NAS server address to assign traffic to the destination.

NAS-Ports: Configure your port No. if you would like to enable Network Address Servecie (NAS) under a SSID.

NAS-ID: Configure a NAS ID which is mapped with the SSID. The traffic will be forwarded via the different SSIDs if these SSIDs configured as different ID.

Radius Settings	
<input type="checkbox"/> NAS-ID	<input type="text"/>
<input type="checkbox"/> NAS-PORT	<input type="text"/> (0 ~ 65535)
<input type="checkbox"/> NAS-IP	<input type="text"/>

Radius Accounting

Radius Accounting: Choose to enable or disable accounting feature.

Radius Accounting Server: Enter the IP address of the Radius accounting server.

Radius Accounting Port Enter the port number used for connections to the Radius accounting server.

Radius Accounting Secret: Enter the secret required to connect to the Radius accounting server.

Interim Accounting Interval: Specifies how often, in seconds, the accounting data sends.

Radius Accounting	
Radius Accounting	<input type="radio"/> Enable <input checked="" type="radio"/> Disable
Radius Accounting Server	<input type="text"/>
Radius Accounting Port	<input type="text"/> 1813
Radius Accounting Secret	<input type="text"/>
Interim Accounting Interval	<input type="text"/> 600

Fast Roaming

Enable the function to serve mobile client devices that roam from Access Point to Access Point. Some applications running on Client devices require fast re-association when they roam to a different Access Point

Fast Roaming ⓘ

Enable Fast Roaming

Enable Disable

Please enter the settings of the SSID and initialize the Security mode to WPA2 or WPA3 enterprise, as well as to set the Radius Server firstly. Then users can enable the Fast Roaming and implement the advanced search.

Please also set the same enterprise Encryption under the same SSID on other Access Points and enable the Fast Roaming. When the configuration is realized on different Access Point, the mobile client devices can run the voice service and require seamless roaming to prevent delay in conversation from Access Point to Access Point.

Wireless MAC Filtering

Wireless MAC Filtering is used to allow or deny network access to wireless clients (computers, tablet PCs, NAS, smartphones, etc.) according to their MAC addresses. You can manually add a MAC address to restrict permission to access the AP. The default setting is: **Disable Wireless MAC Filter**.

Note: Only applicable in Access Point and WDS AP modes.

ACL Mode: Determines whether network access is granted or denied to clients whose MAC addresses appear in the MAC address table on this page. There are three options: Disabled / Allow MAC in the list / Deny MAC in the list.

MAC Address: Enter the MAC address of the wireless client.

Add: Click **Add** to add the MAC address to the MAC address table.

Wireless MAC Filter

ACL Mode: Disabled

MAC Address: [] . [] . [] . [] . [] . []

Add

#	MAC Address
---	-------------

Wireless Traffic Shaping

Traffic shaping regulates the flow of packets leaving an interface to deliver improved Quality of Service(QoS). The function will allow administrators to restrict the wireless bandwidth per SSID or per user.

Wireless Traffic Shaping

Enable Traffic Shaping Enable Disable

Download Limit Per User
Mbps (1-999)

Upload Limit Per User
Mbps (1-999)

Status: Check this option to enable Wireless Traffic Shaping.

Download Limit: Specifies the wireless transmission bandwidth used for downloading.

Upload Limit: Specifies the wireless transmission bandwidth used for uploading.

This limitation can be specified per user.

After filling in those settings, click **Save** to confirm then back to the main page of wireless setting.

Management Interface-2.4G

This Management interface make you can change the configuration via EnWiFi App instead of using the GUI. Management SSID will be turned off in this two situation. (1)When the device is powered up in the first time and there is no connection in 30 minutes. (2)When the setting is done and idle in 15 minutes. If you need to turn on management SSID please reboot the device.You can set to always on or turn off if idle in 15 minutes.

For security, we strongly recommend to change the default passphrase via entering the Edit page.

Management Interface - 2.4G

Enabled	SSID	Edit	Security
<input checked="" type="checkbox"/>	ENMGMT79C393	<input type="button" value="Edit"/>	WPA2/PSK AES

Always on Turn off if idle in 15 minutes

Guest Network Settings

You can add a guest network which allows visitors to use the Internet without providing your office or company wireless security key. You can checked the guest network in specified SSID and proceed the detail setting here.

Guest Network DHCP Server Settings	
Manual IP Settings	
- IP Address	192.168.200.1
- Subnet Mask	255.255.255.0
Automatic DHCP Server Settings	
- Starting IP Address	192.168.200.100
- Ending IP Address	192.168.200.200
- WINS Server IP	0.0.0.0

IP Address: The IP Address of this device.

Subnet Mask: The IP Subnet mask of this device.

Automatic DHCP Server Settings

Starting IP Address: The first IP Address in the range of the addresses by the DHCP server.

Ending IP Address: The last IP Address in the range of addresses assigned by the DHCP server.

WINS server IP: Address for the WINS server.

Management VLAN Settings

This page allows you to assign a VLAN tag to packets sent over the network. A VLAN is a group of computers on a network whose software has been configured so that they behave as if they were on a separate Local Area Network (LAN). Computers on VLAN do not have to be physically located next to one another on the LAN.

Note: Only applicable in Access Point and WDS AP modes.

Management VLAN: If your network includes VLANs, you can enable **Management VLAN ID** for packets passing through the Access Point with a tag.

Save: Click **Save** to confirm the changes or **Cancel** to cancel and return to previous settings.

Note: If you reconfigure the Management VLAN ID, you may lose your connection to the EnStationAC. Verify that the DHCP server supports the reconfigured VLAN ID and then reconnect to the EnStationAC using the new IP address.

Management VLAN Settings	
CAUTION: If you reconfigure the Management VLAN ID, you may lose connectivity to the access point. Verify that the switch and DHCP server can support the reconfigured VLAN ID, and then re-connect to the new IP address.	
Management VLAN	Enable <input type="checkbox"/> 4096

Chapter 7

Mesh



Mesh

Mesh Status

This page allows you to review the status of the mesh network.

Status	
Mesh Status	Disabled
Mesh Interface	
Mesh ID	
Mesh Channel	
Mesh Type	Root Node

[Refresh](#)

Mesh Settings

This page allows you to build up a mesh connection in the wireless network.

Mesh Settings	
Mesh	<input type="radio"/> Enable <input checked="" type="radio"/> Disable
Operation Mode	<input checked="" type="radio"/> Mesh AP <input type="radio"/> Mesh Point
Mesh Device Name	EWS850AP
Mesh Band	<input type="radio"/> 2.4GHz <input checked="" type="radio"/> 5GHz
Mesh ID	<input type="text" value="12345678"/>
Password	<input type="text" value="1234567890"/>
Mesh RSSI	<input type="text" value="-80"/> (dBm)

[Save](#) [Cancel](#)

Mesh: Choose to enable or disable.

Operation Mode: Base on the role of this device to make it as Mesh AP or Mesh Point.

Mesh Device Name: The modle name of this Mesh device.

Mesh ID: To create a mesh network, please enter the ID number of this device for including into Mesh.

Password: Set up a password for this Mesh ID.

Mesh RSSI: The RF level in the mesh network.

Save/Cancel: To instore or remove the setings you have done.

Tools

Node List: Devices list in this Mesh network.

Link Status: This page allows you to review the linking status (RSSI) of each Mesh nodes.

Ping

This page allows you to analyze the connection quality of the device in the network.

Ping Test Parameters

From	<input type="text"/>	To	<input type="text"/>
Number of Pings		<input type="text" value="4"/>	
<input type="button" value="Start"/>			

From/To: Choose the IP address you would like to ping in this Mesh network.

Number of Pings: Enter the number of times you wish to ping.

Start: Click start to proceed ping test.

Traceroute

This page allows you to trace the routing table to a target in the network.

Traceroute Test Parameters

From	<input type="text"/>	To	<input type="text"/>
<input type="button" value="Start"/>			

From/To: Choose the IP address you would like to trace.

Start: Click start to proceed traceroute test.

Throughput Test

Choose the target device you would like to test the throughput performance.

Throughput Test

<input type="text"/>	And	<input type="text"/>	<input type="button" value="Start"/>
----------------------	-----	----------------------	--------------------------------------

Chapter 8

Management



Advanced Settings

Controller Settings

Controller Address (Auto detection if leave empty):

If the device is managing by controller, it will show the address.

Controller Settings

Controller Address(Auto detection if leave empty)		<input type="text"/>	Test
Connection Status	Connect to #		
Registration Check Code	6f7e95c9		

SNMP Settings

This page allows you to assign the Contact Details, Location, Community Name, and Trap Settings for a Simple Network Management Protocol (SNMP). SNMP is a networking management protocol used to monitor network attached devices. SNMP allows messages (called protocol data units) to be sent to various parts of the network. Upon receiving these messages, SNMP compatible devices (called agents) returns the data stored in their Management Information Bases.

SNMP Settings	
Status	Enable ▾
Contact	<input type="text"/>
Location	<input type="text"/>
Port	161
Community Name (Read Only)	public
Community Name (Read Write)	private
Trap Destination	
- Port	162
- IP Address	<input type="text"/>
- Community Name	public
SNMPv3 Settings	
- Status	Enable ▾
- Username	admin (1-31 Characters)
- Authorized Protocol	MD5 ▾
- Authorized Key	12345678 (8-32 Characters)
- Private Protocol	DES ▾
- Private Key	12345678 (8-32 Characters)
- Engine ID	<input type="text"/>

Status: Enables or disables the SNMP feature.

Contact: Specifies the contact details of the device.

Location: Specifies the location of the device.

Community Name (Read Only): Specifies the password for the SNMP community for read only access.

Community Name (Read/Write): Specifies the password for the SNMP community with read/write access.

Trap Destination Address: Specifies the IP address of the computer that will receive the SNMP traps.

Trap Destination Community Name: Specifies the password for the SNMP trap community.

SNMPv3: Enables or disables the SNMPv3 feature.

User Name: Specifies the username for SNMPv3.

Auth Protocol: Selects the authentication protocol type: MDS or SHA.

SAuth Key: Specifies the authentication key.

Priv Protocol: Selects the privacy protocol type: DES.

Priv Key: Specifies the privacy key for privacy.

Engine ID: Specifies the engine ID for SNMPv3.

Apply Save: Click **Apply Save** to apply the changes.

SSH: Enable Secure Shell (SSH) to make secure, encrypted connections in the network. Secure Shell is a network protocol that allows data to be exchanged using a secure channel between two network devices.

HTTPS: Enable HTTPS to transfer and display web content securely. The Hypertext Transfer Protocol over SSL (Secure Socket Layer) is a TCP/IP protocol used by web servers to transfer and display web content securely.

CLI Settings

CLI Setting	
CLI	Enable ▾
SSH Setting	
SSH	Disable ▾
HTTPS Setting	
HTTPS	Enable ▾
HTTPS forward	Disable ▾

CLI: The Command Line Interface (CLI) allows you to type commands instead of choosing them from a menu or selecting an icon.

Email Alert

You can use the Email Alert feature to send messages to the configured email address when particular system events occur.

Note: Do **NOT** use your personal email address as it can unnecessarily expose your personal email login credentials. Use a separate email account made for this feature instead

Email Alert	
Status	<input checked="" type="checkbox"/> Enable
- From	<input type="text"/>
- To	<input type="text"/>
- Subject	[Email-Alert][ENH900EXT][00:02:6F:FF:FF:FF] Config
Email Account	
- Username	<input type="text"/>
- Password	<input type="text"/>
- SMTP Server	<input type="text"/> Port: 25
- Security Mode	None <input type="button" value="Send Test Mail"/>

From: Enter the email address to show the sender of the email.

To: Enter the address that you wish to send emails to.

Subject: Enter the text that you wish to appear in the email's subject line.

Username: Enter the username for the email account that will be used to send emails.

Password: Enter the password for the email account that will be used to send emails.

SMTP Server: Enter the IP address or hostname of the outgoing SMTP server.

Port: Enter the SMTP port number to use for outbound emails.

Security Mode: Selects the security mode: SSL/TLS or STARTTLS or None.

Apply: To save setting and take effect.

Time Zone

Date and Time Setting

This page allows you to set the internal clock of the device.

Date and Time Settings

Manually Set Date and Time

Date: 2019 / 07 / 09

Time: 15 : 03 (24-Hour)

Synchronize with PC

Automatically Get Date and Time

NTP Server: pool.ntp.org

Manually Set Date and Time: Manually specify the date and time.

Automatically Get Date and Time: Select and check whether you wish to enter the IP address of an NTP server or use the default NTP server to have the internal clock set automatically.

Time Zone

You can click Auto Detect or select Time Zone from the menu.

Enable Daylight Saving: Check whether daylight savings applies to your area.

Start: Select the day, month, and time when daylight savings time starts.

End: Select the day, month, and time when daylight savings times ends.

Time Zone

Auto Detect

Time Zone: UTC+00:00 England

Enable Daylight Saving

Start: January 1s Sun 00:00

End: January 1s Mon 00:00

Auto Reboot Settings

You can specify how often you wish to reboot the device.

Auto Reboot Setting	
Auto Reboot Status	<input type="button" value="Disable"/>
Timer	<input type="checkbox"/> Sunday <input type="checkbox"/> Monday <input type="checkbox"/> Tuesday <input type="checkbox"/> Wednesday <input type="checkbox"/> Thursday <input type="checkbox"/> Friday <input type="checkbox"/> Saturday
	<input type="text" value="0"/> : <input type="text" value="0"/>

Auto Reboot Setting: Enables or disables the Auto Reboot function.

Frequency of Auto Reboot: Specifies how often you wish to reboot the EnStationAC by Min, Hour, Day or Week.

Timer: Select the day and enter the time you would like to reboot automatically.

Save: Click **Save** to apply the changes.

Wi-Fi Scheduler

The Wi-Fi Scheduler can be created for use in enforcing rules. For example, if you wish to restrict web access to Mon-Fri from 3pm to 8pm, you could create a schedule selecting Mon, Tue, Wed, Thu and Fri while entering a Start time of 3pm and End Time of 8pm to limit access to these times.

WiFi Scheduler

Enable Disable

Status **NOTE:** Please assure that the Time Zone Settings is synced with your local time when enabling the Wi-Fi Scheduler.

Wireless Radio

SSID Selection

Schedule Templates

Day	Availability	Duration
Sunday	<input type="text" value="available"/>	00 : 00 ~ 24 : 00
Monday	<input type="text" value="available"/>	00 : 00 ~ 24 : 00
Tuesday	<input type="text" value="available"/>	00 : 00 ~ 24 : 00
Wednesday	<input type="text" value="available"/>	00 : 00 ~ 24 : 00
Thursday	<input type="text" value="available"/>	00 : 00 ~ 24 : 00
Friday	<input type="text" value="available"/>	00 : 00 ~ 24 : 00
Saturday	<input type="text" value="available"/>	00 : 00 ~ 24 : 00

Status: Enables or disables the Wi-Fi scheduler function.

Wireless Radio: Select 2.4 GHz or 5 GHz from the drop-down list for the preferred band type.

SSID Selection: Select a SSID from the drop-down list.

Schedule Templates: Select a schedule template from the

drop-down list.

Day(s): Place a checkmark in the boxes for the desired days or select the **All Week** radio button to select all seven days of the week.

Duration: The Start Time is entered in two fields. The first box is for hours and the second box is for minutes. The End Time is entered in the same format as the Start time.

Tools

Ping Test

This page allows you to analyze the connection quality of the device and trace the routing table to a target in the network.

Ping Test Parameters	
Target IP / Domain Name	<input type="text"/>
Ping Packet Size	64 Bytes
Number of Pings	4
<input type="button" value="Start"/>	<div style="border: 1px solid #ccc; height: 100px;"></div>

Target IP: Enter the IP address you would like to search.

Ping Packet Size: Enter the packet size of each ping.

Number of Pings: Enter the number of times you wish to ping.

Start: Click start to proceed ping test.

Traceroute Test

Target IP/ Domain Name: Enter the IP address or domain name you would like to trace

Traceroute Test Parameters	
Target IP / Domain Name	<input type="text"/>
<input type="button" value="Start"/> <input type="button" value="Stop"/>	<div style="border: 1px solid #ccc; height: 100px;"></div>

Nslookup Test

Target IP/ Domain Name: Enter the IP address or domain name you would like to do Nslookup test.

Nslookup Test Parameters ?	
Target IP / Domain Name	<input type="text"/>
<input type="button" value="Start"/>	

Speed Test

Target IP / Domain Name: Enter an IP address or domain name you wish to implement a speed test for realizing the variance on wireless speed.

Time Period: Enter the time in seconds that you would like the test to implement for and in how many intervals.

IPv4/IPv6 Port: This Access Points uses IPv4 5001 and IPv6 60001 port for the speed test.

Start: Click start to implement speed test.

Speed Test Parameters

Target IP / Domain Name	<input type="text"/>
Time Period	<input type="text" value="20"/> Sec
Check Interval	<input type="text" value="5"/> Sec
IPv4Port	<input type="text" value="5001"/>
IPv6Port	<input type="text" value="5002"/>
<input type="button" value="Start"/>	

Device Discovery

This page allows you to discover devices from network for Operation Mode, IP Address, System MAC Address and Firmware version.

Device Discovery				
Device Name	Operation Mode	IP Address	System MAC Address	Firmware Version
<input type="button" value="Scan"/>				

Chapter 9

System Management



System Manager

Account

This page allows you to change the device username and password. By default, the username is: **admin** and the password is: **admin**. The password can contain from 0 to 12 alphanumeric characters and is case sensitive. After this changes applies, you need to login again.

Account Settings

Account Settings	
Administrator Username	admin
Current Password	
New Password	
Verify Password	

Apply saved settings to take effect

Administrator Username: Enter a new username for logging in to the New Name entry box.

Current Password: Enter the old password for logging in to the Old Password entry box.

New Password: Enter the new password for logging in to the New Password entry box.

Verify Password: Re-enter the new password in the Confirm Password entry box for confirmation.

Apply: Click **Apply** to apply the changes.

Firmware Firmware Upgrade

This page allows you to upgrade the firmware of the device.

Firmware Upgrade

Current Firmware Version: 2.0.0

Select the new firmware from your hard disk.

No file selected.

To Perform the Firmware Upgrade:

1. Click the **Choose File** button and navigate the OS file system to the location of the upgrade file.
2. Select the upgrade file. The name of the file will appear in the Upgrade File field.
3. Click the **Upload** button to commence the firmware upgrade.

Note: The device is unavailable during the Firmware upgrade process and must restart when the upgrade is completed. Any connections to or through the device will be lost.

Backup/Restore

This page allows you to save the current device configurations. When you save your configurations, you also can reload the saved configurations into the device through the Restore Saved Settings from a file section. If extreme problems occur, or if you have set the AP incorrectly, you can use the **Reset** button in the Revert to Factory Default Settings section to restore all the configurations of the AP to the original default settings.

Factory Setting

Backup Setting: Click **Export** to save the current configured settings.

Restore New Setting: To restore settings that have been previously backed up, click **Browse**, select the file, and click **Restore**.

Restore to Default: Click **Reset** button to restore the AP to its factory default settings.

User Setting

The function allows you to backup the current device configurations into the EnStationAC as the default value. If extreme problems occur, or if you have set the EnStationAC incorrectly, you can push the Reset button to revert all the configurations of the EnStationAC to the user default.

Back Up Setting as Default: Click **Backup** to backup the user settings you would like to the device's memory for the default settings.

Restore to User Default: Click **Restore** to restore user settings to the factory standard settings.

Backup/Restore Settings

Factory Setting	
- Backup Setting ⓘ	Export
- Restore New Setting	選擇檔案 未選擇任何檔案 Import
- Reset to Default ⓘ	Reset
User Setting	
- Back Up Setting as Default	Backup
- Restore to User Default ⓘ	Restore

- **Caution:** Please write down your account number and password before saving. The user settings will now become the new default settings at the next successful login.

Note1: After setting the current settings as the default, you should click the **Restore to Default** on the web interface for reverting the settings into the factory default instead of pushing the reset button.

Note2: Please **write down** your account and password before saving. The user settings will now become the new default settings at the next successful login.

Log

System Log

The EnStationAC automatically logs (records) events of possible interest in its internal memory. To view the logged information, click the **Log** link under the System Manager menu. If there is not enough internal memory to log all events, older events are deleted from the log. When powered down or rebooted, the log will be cleared.

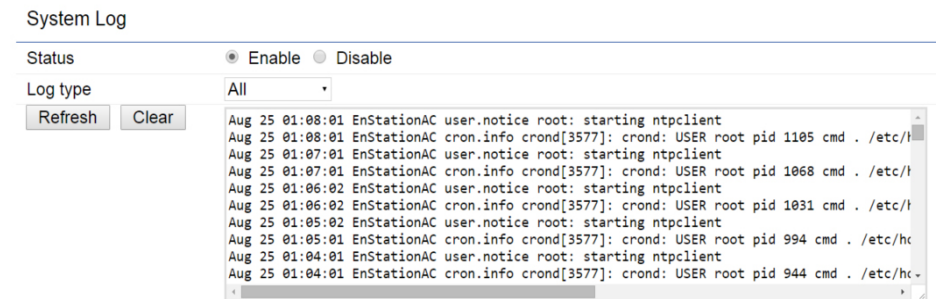

Status: Enable/Disable this function.

Traffic Log: Enable/Disable this function.

Log type: You may choose one of log types to display logs in the following window. The default log types is All.

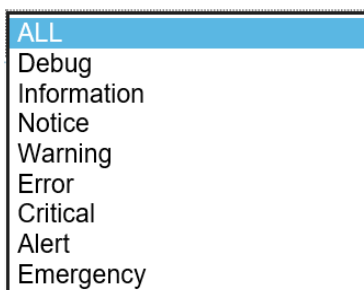

Remote Log

This page allows you to setup the Remote Log functions for the AP/CPE.



Syslog: Enables or disables the syslog function.

Log Server IP Address: Enter the IP address of the log server.

Remote Log: Enable or disable the remote log service.

Apply: Click **Apply** to apply the changes.

Logout

Click **Logout** in Management menu if you want to logout from the device.

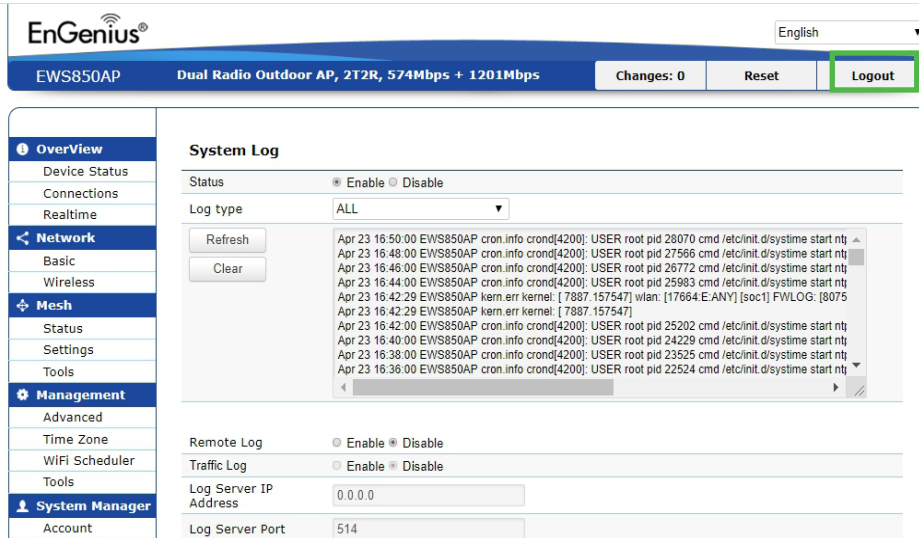

*The model name will be varied by different models.

Please confirm again to logout the system or not.

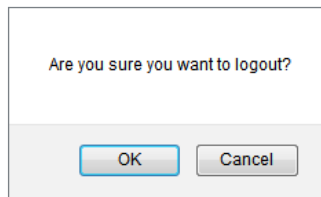

Reset

In some circumstances, it may be required to force the device to reboot. Click on **Reset** to reboot or to reset the device.

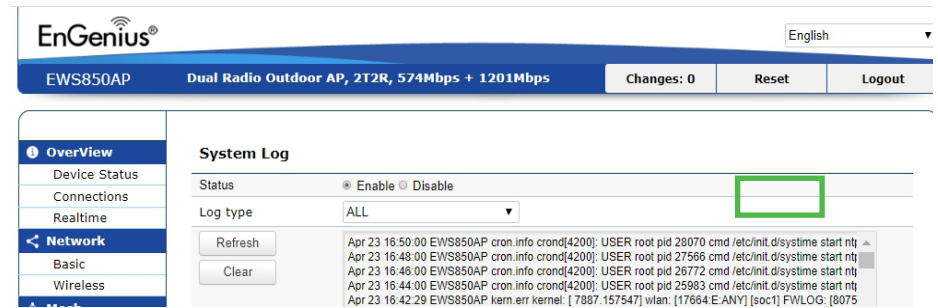

*The model name will be varied by different models.

Once you click reset button, you will see the options for reboot or restore this AP.

Reboot the device: Click it to reboot this device.

Restore to Factory Default: Click it to reset this device to factory default setting.

Restore to User Default: Click it to reset this device to user default settings.

Reboot the Device

CAUTION: The device will be rebooted when pressing this button.

Reboot the Device

Restore the device to default settings

CAUTION: All settings will be cleared and reset to either factory default or user default.

Restore to Factory Defaults

Restore to User Default

Chapter 10

EnWiFi App



About EnWiFi App

EnWiFi is a convenient Wi-Fi management tool for EnGenius-brand outdoor and indoor Wi-Fi devices. Configure and monitor EnGenius Wi-Fi device from a smartphone or tablet. EnWifi offers single or group device configuration and updates on your network's latest status. You can access to EnGenius devices anytime via EnWiFi.

Features

Single Configuration

Proceed single device configuration throughout EnWiFi App. The Configuration could be assisted users to fulfill settings on Wireless, Network and Systems.

Group Configuration

Users can create a group configuration for multiple wireless access points and change between Client Bridge, WDS AP, WDS Bridge, WDS Station modes and EnGenius ERP easily.

Device Management

Realize status of an Access Point on RF information and real time throughput on Tx and Rx ways to make maximum PtP connecting performance or remove device with weak signal.

Discover Device

Discover EnGenius Device nearby and access to it to do management quickly.

Connected Status Monitor

Monitor connected devices on signal level (RSSI), transmit / receive performance, and firmware version. Users can enhance device settings base on these connected information.

Backup and Restore

Backup current configuring file and restore to other devices quickly.

Configuring Device in EnWiFi App

Before access to device, you need to find Management SSID and connect to it first. Then you can see your device in the Device List.

Single Configuration

Proceed Wireless Settings, Network and System Configuration to setup value on RF parameters, DHCP/Spanning Tree, and time zone for a device.

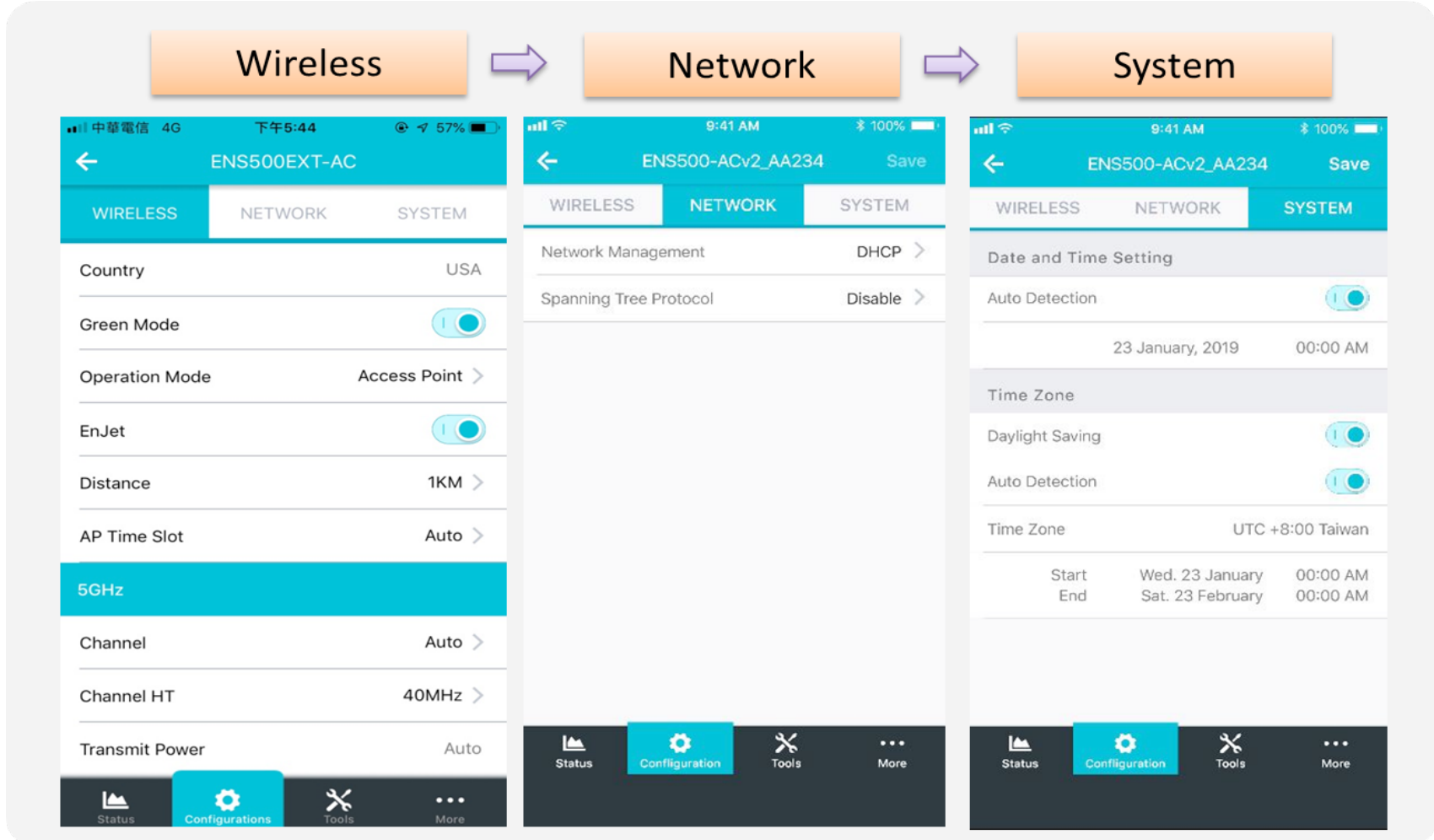

WDS Link

Setting WDS links will assist users to setup peer-to-peer connection easily.

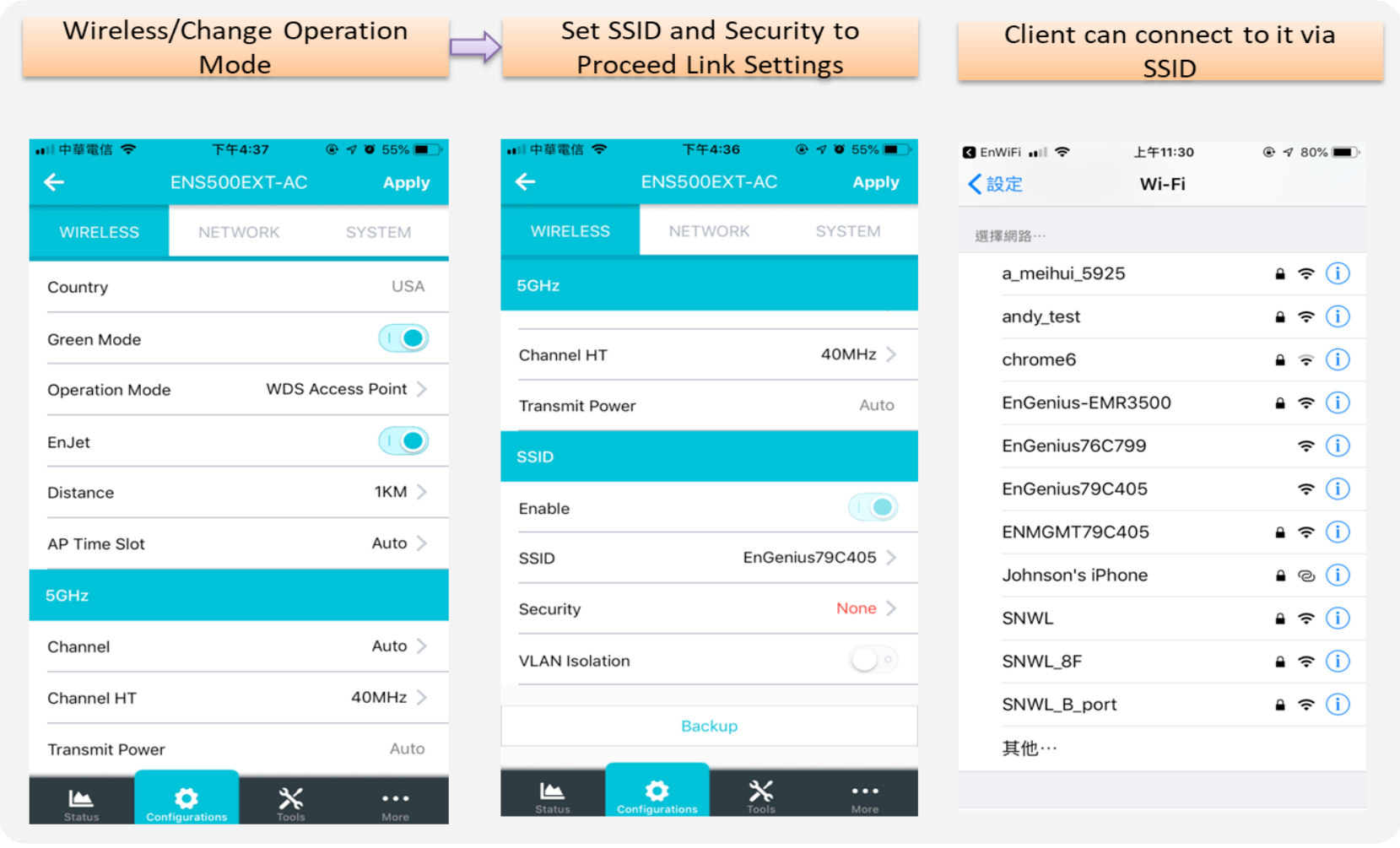

Group Configuration

Proceed Wireless Settings including EnJet, Operation mode, distance and time slot, channel used, channel HT, Tx power and Security

Select Operation Modes, EnJet and Radio Firstly. → Check Status for Access Points → Proceed Wireless Setting

Device List

Device Name	IP Address	EnJet
ENS500-AC	192.168.0.108	On
ENS500-AC	192.168.0.114	On
ENS500EXT-AC	192.168.0.113	On
EnStation5-AC	192.168.0.111	On

Model Selected (FCC)

Device Name	IP Address	EnJet
ENS500-AC	192.168.0.114	On
ENS500EXT-AC	192.168.0.113	On
ENS500-AC	192.168.0.108	On
EnStation5-AC	192.168.0.111	On

Wireless Setting

Country	USA
Green Mode	On
Operation Mode	Access Point
EnJet	On
Distance	1KM
AP Time Slot	Auto
5GHz	Selected
Channel	Auto
Channel HT	40MHz
Transmit Power	Auto

Group Configuration

Proceed Wireless Settings including EnJet, Operation mode, distance and time slot, channel used, channel HT, Tx power and

Select Operation Modes, EnJet and Radio Firstly. → Check Status for Access Points → Proceed Wireless Setting

Device List

Device Model	IP Address	EnJet
ENS500-AC	192.168.0.108	On
ENS500-AC	192.168.0.114	On
ENS500EXT-AC	192.168.0.113	On
EnStation5-AC	192.168.0.111	On

Model Selected

Device Model	IP Address	EnJet
<input type="checkbox"/> ENS500-AC	192.168.0.114	On
<input type="checkbox"/> ENS500EXT-AC	192.168.0.113	On
<input type="checkbox"/> ENS500-AC	192.168.0.108	On
<input type="checkbox"/> EnStation5-AC	192.168.0.111	On

Wireless Setting

- Country: USA
- Green Mode:
- Operation Mode: Access Point
- EnJet:
- Distance: 1KM
- AP Time Slot: Auto
- 5GHz: Selected
- Channel: Auto
- Channel HT: 40MHz
- Transmit Power: Auto

Proceed configuration on IP/Subnet, time Setting, and account/password under a group.

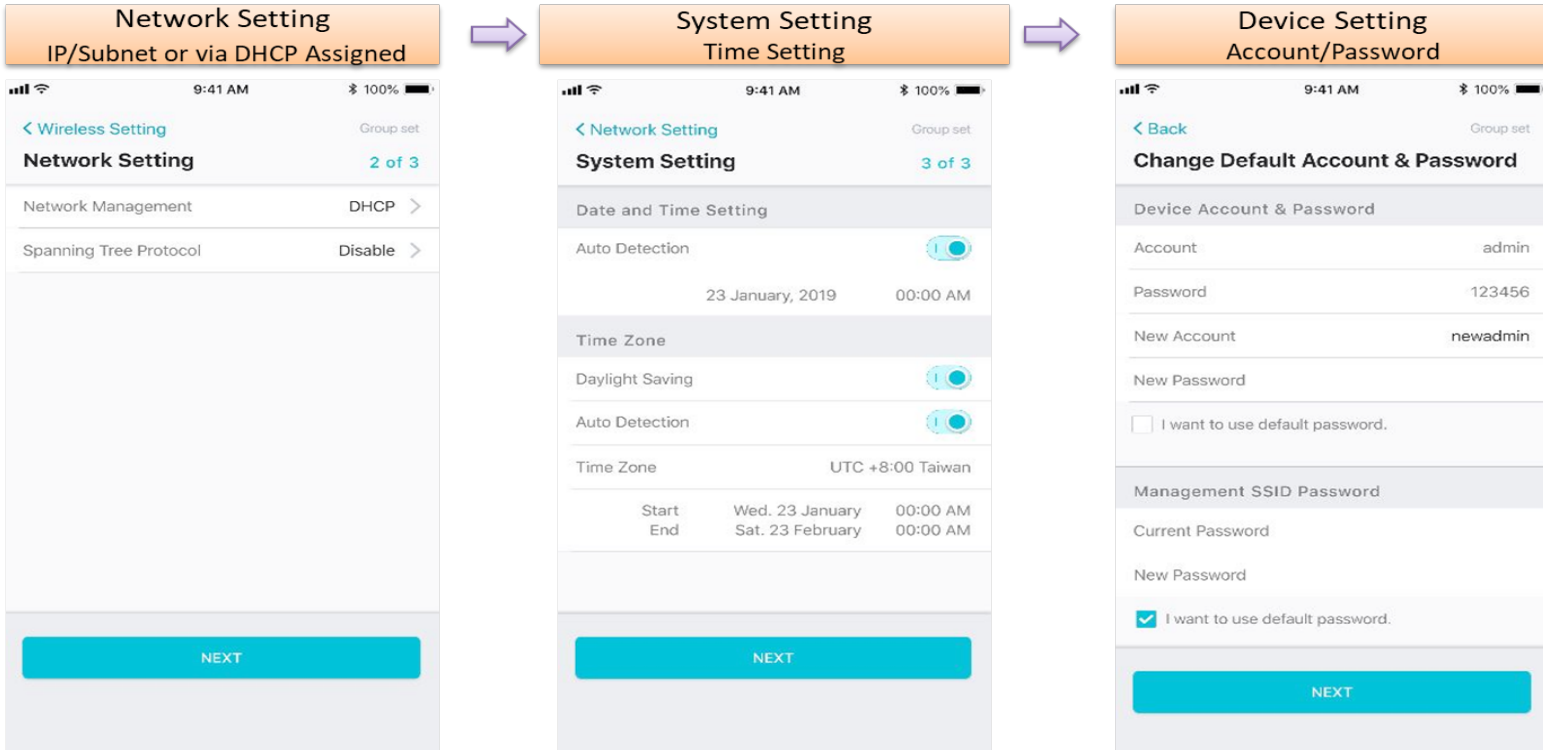

You also can use EnWiFi App to proceed connection from Client Bridge mode devices to an Access Point mode device.

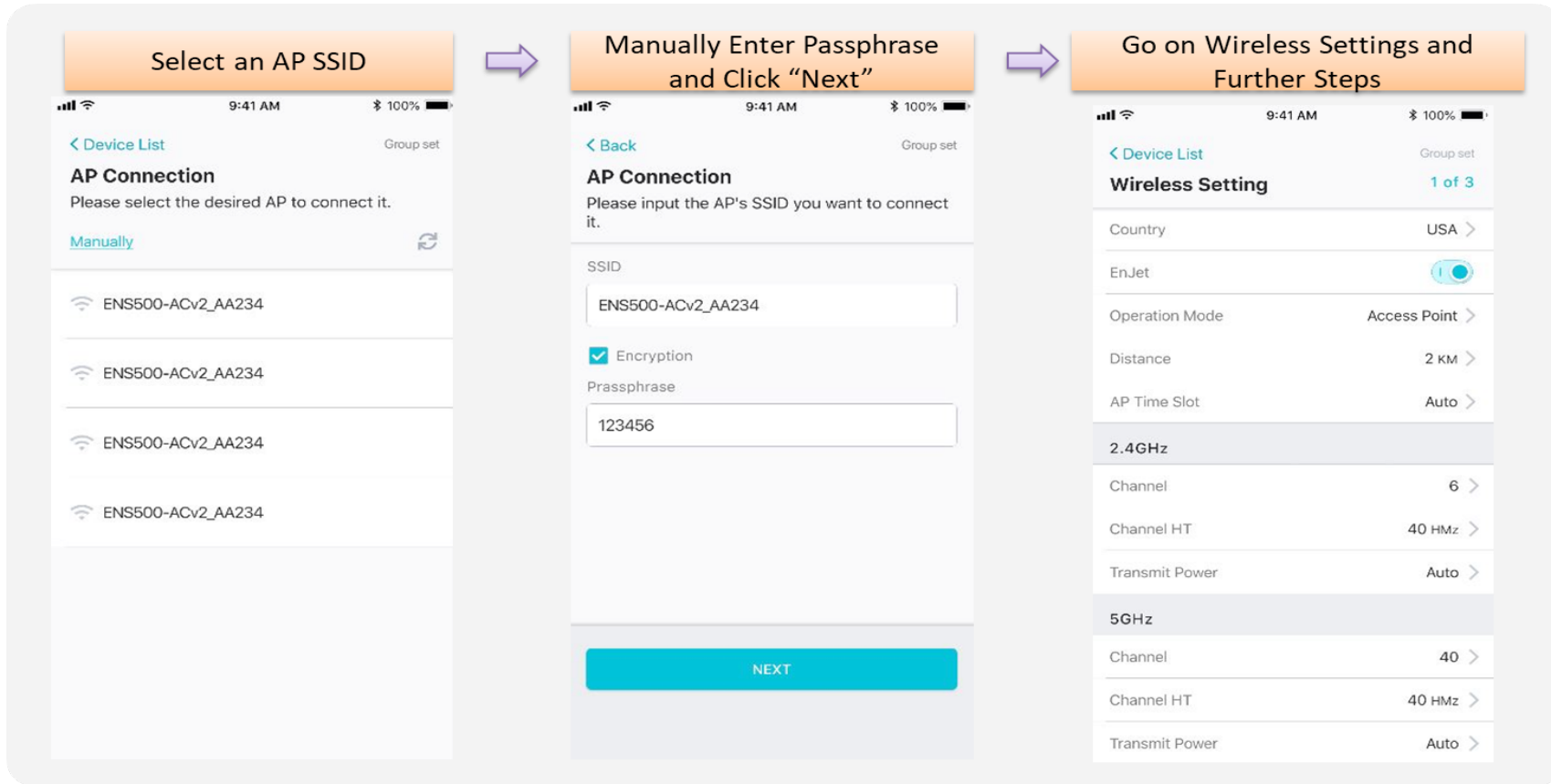

You also can set Operation mode to WDS AP mode and let WDS STA devices connect to this WDS AP mode device.

Select operation mode to WDS AP and choose AP

Configure wireless Setting

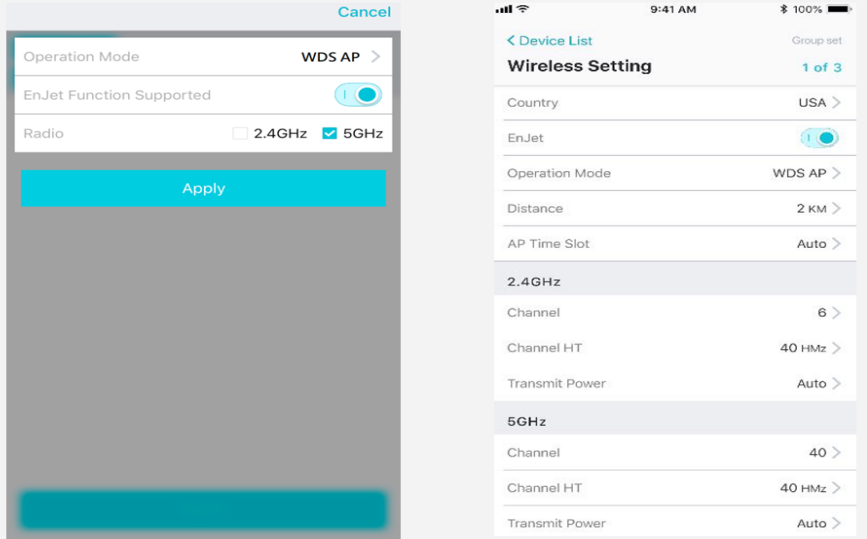

The image shows two screenshots from a mobile application. The left screenshot is titled "Select operation mode to WDS AP and choose AP". It features a "Cancel" button at the top right. Below it, there is a section for "Operation Mode" with a dropdown menu set to "WDS AP". Underneath, there is a toggle for "EnJet Function Supported" which is turned on. At the bottom, there is a "Radio" section with two options: "2.4GHz" (unchecked) and "5GHz" (checked). A large blue "Apply" button is at the bottom. The right screenshot is titled "Configure wireless Setting". It shows a "Device List" at the top. Below it, the "Wireless Setting" screen is displayed, labeled "1 of 3". It includes fields for "Country" (USA), "EnJet" (turned on), "Operation Mode" (WDS AP), "Distance" (2 KM), and "AP Time Slot" (Auto). There are two sections for frequency bands: "2.4GHz" and "5GHz". Each section has fields for "Channel", "Channel HT", and "Transmit Power".

Select operation mode to WDS STA and choose AP to connect

Configure wireless Setting

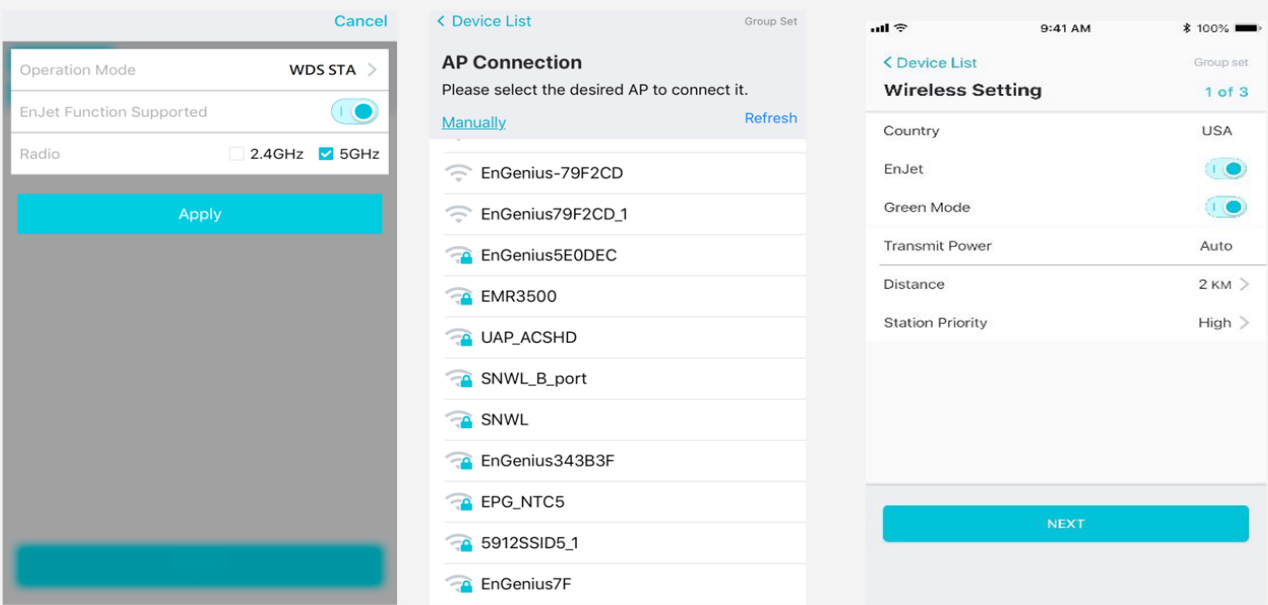

The image shows two screenshots from a mobile application. The left screenshot is titled "Select operation mode to WDS STA and choose AP to connect". It features a "Cancel" button at the top right. Below it, there is a section for "Operation Mode" with a dropdown menu set to "WDS STA". Underneath, there is a toggle for "EnJet Function Supported" which is turned on. At the bottom, there is a "Radio" section with two options: "2.4GHz" (unchecked) and "5GHz" (checked). A large blue "Apply" button is at the bottom. The middle screenshot is titled "AP Connection". It shows a "Device List" at the top. Below it, the "AP Connection" screen is displayed, labeled "1 of 3". It includes a "Please select the desired AP to connect it." message and a "Refresh" button. A list of APs is shown, including "EnGenius-79F2CD", "EnGenius79F2CD_1", "EnGenius5E0DEC", "EMR3500", "UAP_ACSHD", "SNWL_B_port", "SNWL", "EnGenius343B3F", "EPG_NTC5", "5912SSID5_1", and "EnGenius7F". The right screenshot is titled "Configure wireless Setting". It shows a "Device List" at the top. Below it, the "Wireless Setting" screen is displayed, labeled "1 of 3". It includes fields for "Country" (USA), "EnJet" (turned on), "Green Mode" (turned on), "Transmit Power" (Auto), "Distance" (2 KM), and "Station Priority" (High). A large blue "NEXT" button is at the bottom.

Discover Device

Discover and Access to other EnGenius devices to manage their status.

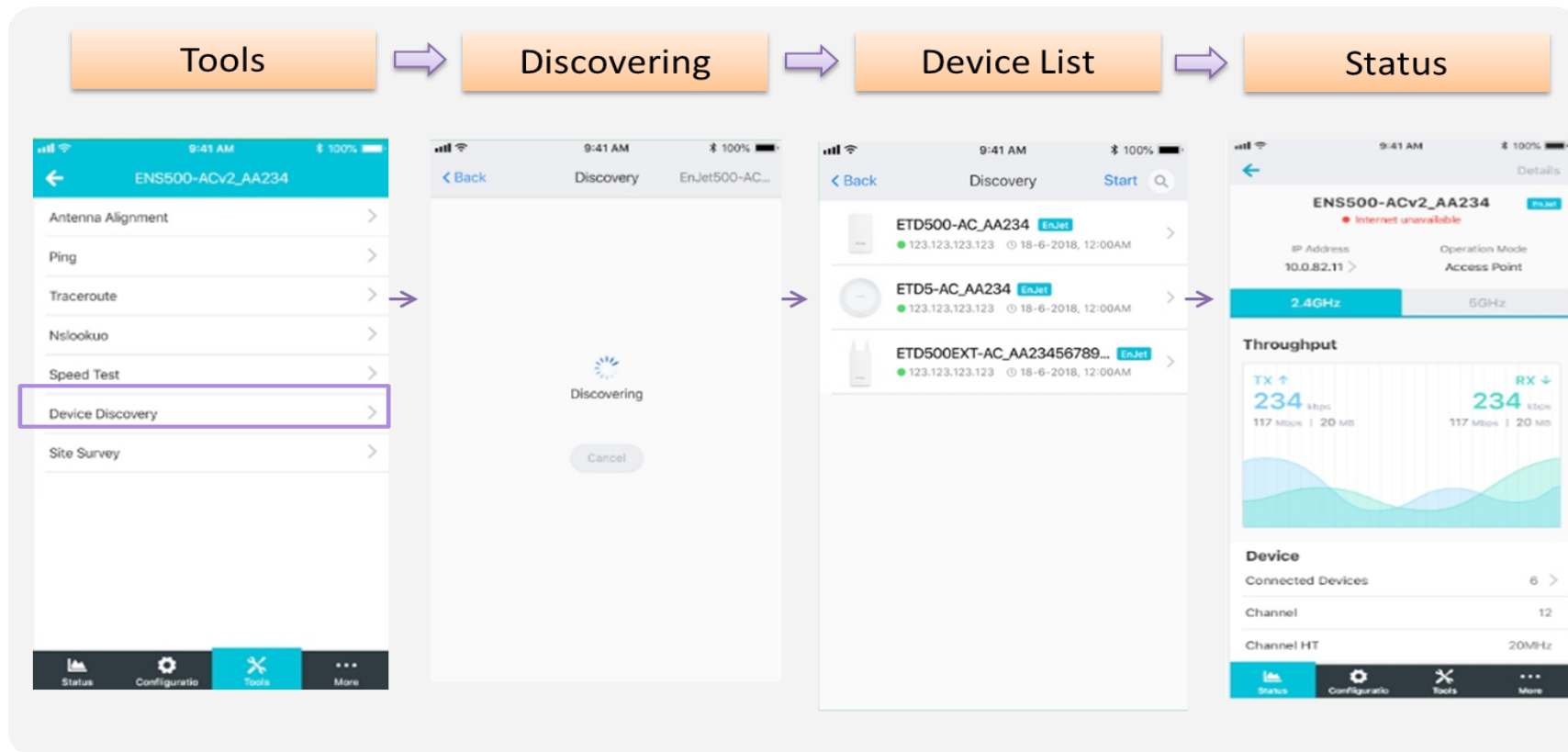

Monitor & Management

Monitor clients connected status. Base on this information to adjust configuration or press kick out to remove device if the signal is weak .

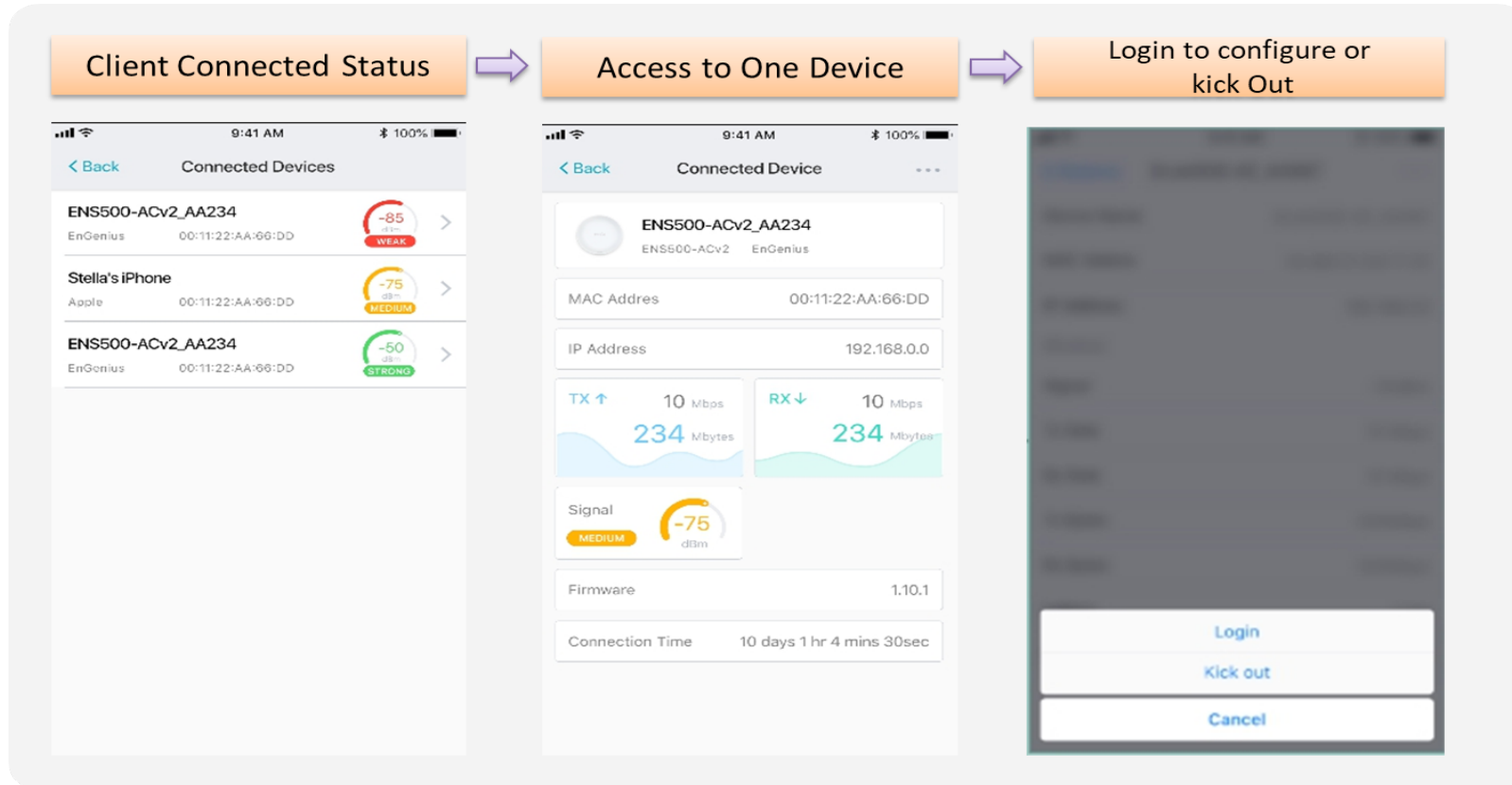

Backup

Backup current settings as a configuration file to apply to other devices quickly.

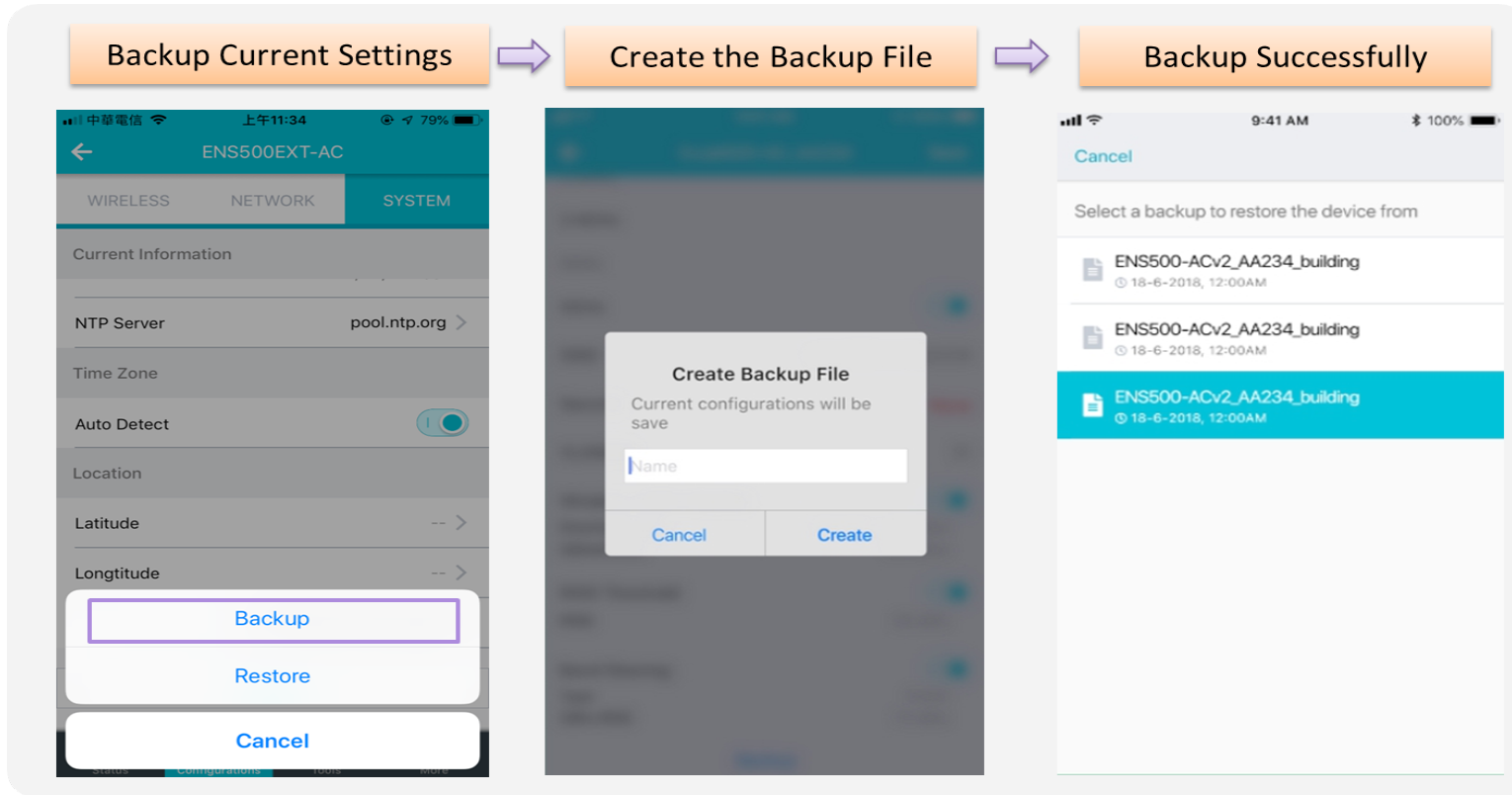

Restore

Choose backup file to restore other devices so that they can have the same configuration quickly.

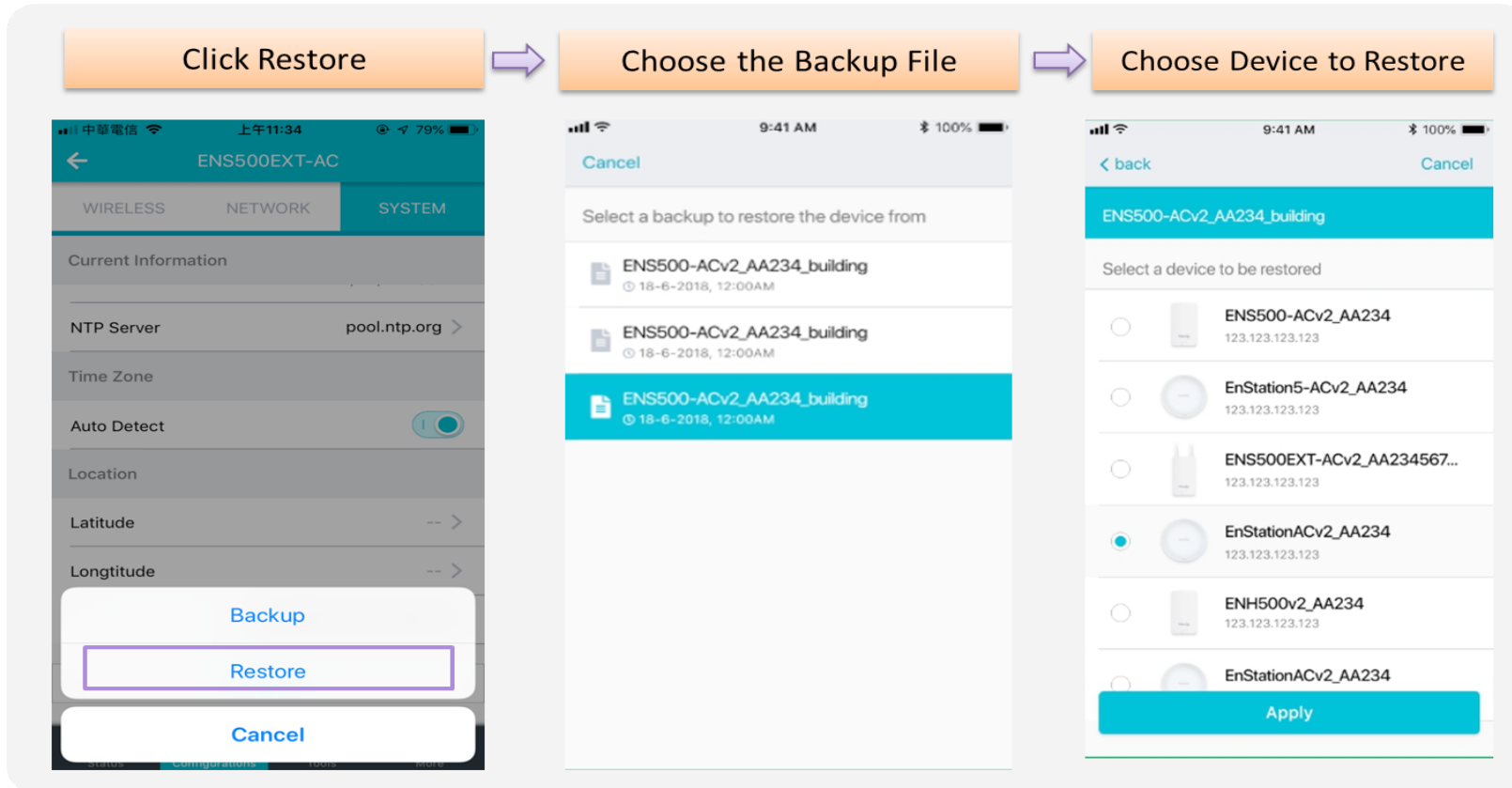

Appendix

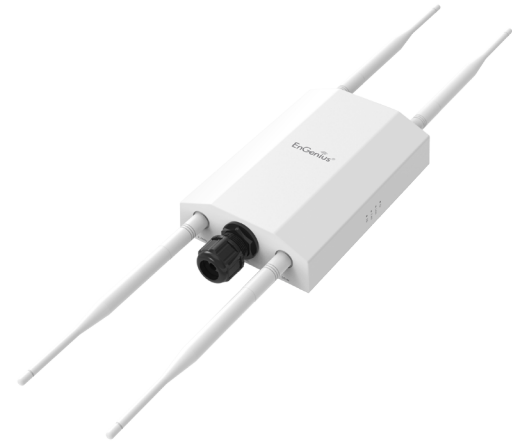

Appendix A - FCC Interference Statement

Federal Communication Commission Interference Statement

This device complies with Part 15 of the FCC Rules. Operation is subject to the following two conditions: (1) This device may not cause harmful interference, and (2) this device must accept any interference received, including interference that may cause undesired operation. This device and its antenna(s) must not be co-located or operating in conjunction with any other antenna or transmitter. For product available in the USA/Canada market, only channel 1~11 can be operated. Selection of other channels is not possible. Section 15.204(b) states that an approved "transmission system" must always be marketed as a complete system including the antenna.

This equipment has been tested and found to comply with the limits for a Class B digital device, pursuant to Part 15 of the FCC Rules. These limits are designed to provide reasonable protection against harmful interference in a residential installation. This equipment generates, uses and can radiate radio frequency energy and, if not installed and used in accordance with the instructions, may cause harmful interference to radio communications. However, there is no guarantee that interference will not occur in a particular installation. If this equipment does cause harmful interference to radio or television reception, which can be determined by turning the equipment off and on, the user is encouraged to try to correct the interference by one of the following measures:

- Reorient or relocate the receiving antenna.
- Increase the separation between the equipment and receiver.
- Connect the equipment into an outlet on a circuit different from that to which the receiver is connected.
- Consult the dealer or an experienced radio/TV technician for help



FCC Caution:

Any changes or modifications not expressly approved by the party responsible for compliance could void the user's authority to operate this equipment.

This transmitter must not be co-located or operating in conjunction with any other antenna or transmitter.

IMPORTANT NOTE:

Radiation Exposure Statement

This equipment complies with FCC radiation exposure limits set forth for an uncontrolled environment. This equipment should be installed and operated with a minimum distance of 20 cm between the radiator & your body.

Appendix B - Professional Installation Instruction (FCC)

Installation Personal

This product is designed for specific application and needs to be installed by a qualified personal who has RF and related rule knowledge. The general user shall not attempt to install or change the setting.

Installation Location

The product shall be installed at a location where the radiating antenna can be kept 20 cm from nearby person in normal operation condition to meet regulatory RF exposure requirement.

External Antenna

Use only the antennas which have been approved by the applicant. The non-approved antenna(s) may produce unwanted spurious or excessive RF transmitting power which may lead to the violation of FCC limit and is prohibited.

Installation Procedure

Please refer to user's manual for the detail.



Warning:

Please carefully select the installation position and make sure that the final output power does not exceed the limit set force in relevant rules. The violation of the rule could lead to serious federal penalty.

Appendix C - IC Interference Statement

Industry Canada statement

This device contains licence-exempt transmitter(s)/receiver(s) that comply with Innovation, Science and Economic Development Canada's licence-exempt RSS(s). Operation is subject to the following two conditions:

1. This device may not cause interference.
2. This device must accept any interference, including interference that may cause undesired operation of the device.

Le présent appareil est conforme aux CNR d'ISED applicables aux appareils radio exempts de licence. L'exploitation est autorisée aux deux conditions suivantes : (1) le dispositif ne doit pas produire de brouillage préjudiciable, et (2) ce dispositif doit accepter tout brouillage reçu, y compris un brouillage susceptible de provoquer un fonctionnement indésirable.



Caution:

where applicable, antenna type(s), antenna models(s), and worst-case tilt angle(s) necessary to remain compliant with the e.i.r.p. elevation mask requirement set forth in section 6.2.2.3 shall be clearly indicated.



Avertissement:

lorsqu'il y a lieu, les types d'antennes (s'il y en a plusieurs), les numéros de modèle de l'antenne et les pires angles d'inclinaison nécessaires pour rester conforme à l'exigence de la p.i.r.e. applicable au masque d'élévation, énoncée à la section 6.2.2.3, doivent être clairement indiqués.

IMPORTANT NOTE:

Radiation Exposure Statement

This equipment complies with ISED radiation exposure limits set forth for an uncontrolled environment. This equipment should be installed and operated with minimum distance 20cm between the radiator & your body.

Déclaration d'exposition aux radiations:

Cet équipement est conforme aux limites d'exposition aux rayonnements ISED établies pour un environnement non contrôlé. Cet équipement doit être installé et utilisé avec un minimum de 20 cm de distance entre la source de rayonnement et votre corps.

DETACHABLE ANTENNA USAGE

This radio transmitter (IC: 10103A-EWS850AP) has been approved by ISED to operate with the antenna type listed below with maximum permissible gain indicated. Antenna types not included in this list, having a gain greater than the maximum gain indicated for that type, are strictly prohibited for use with this device.

Le présent émetteur radio (IC: 10103A-EWS850AP) a été approuvé par ISED pour fonctionner avec les types d'antenne énumérés ci-dessous et ayant un gain admissible maximal. Les types d'antenne non inclus dans cette liste, et dont le gain est supérieur au gain maximal indiqué, sont strictement interdits pour l'exploitation de l'émetteur.

Approved antenna(s) list

EWS850AP

Type	Gain	Brand	Manufacturer
2.4GHz Dipole	5.17dBi	Master Wave Technology	Master Wave Technology
5 GHz Dipole	5.17dBi	Master Wave Technology	Master Wave Technology

Appendix D

Professional installation instruction (IC)

1. Installation personal

This product is designed for specific application and needs to be installed by a qualified personal who has RF and related rule knowledge. The general user shall not attempt to install or change the setting.

2. Installation location

The product shall be installed at a location where the radiating antenna can be kept 20cm from nearby person in normal operation condition to meet regulatory RF exposure requirement.

3. External antenna

Use only the antennas which have been approved by the applicant. The non-approved antenna(s) may produce unwanted spurious or excessive RF transmitting power which may lead to the violation of FCC/ISED limit and is prohibited.

4. Installation procedure

Please refer to user's manual for the detail.

5. Warning

Please carefully select the installation position and make sure that the final output power does not exceed the limit set force in relevant rules. The violation of the rule could lead to serious federal penalty.

Instructions d'installation professionnelle

1. Installation

Ce produit est destiné à un usage spécifique et doit être installé par un personnel qualifié maîtrisant les radiofréquences et les règles s'y rapportant. L'installation et les réglages ne doivent pas être modifiés par l'utilisateur final.

2. Emplacement d'installation

En usage normal, afin de respecter les exigences réglementaires concernant l'exposition aux radiofréquences, ce produit doit être installé de façon à respecter une distance de 20cm entre l'antenne émettrice et les personnes.

3. Antenne externe.

Utiliser uniquement les antennes approuvées par le fabricant. L'utilisation d'autres antennes peut conduire à un niveau de rayonnement essentiel ou non essentiel dépassant les niveaux limites définis par FCC/ISED, ce qui est interdit.

4. Procédure d'installation

Consulter le manuel d'utilisation.

5. Avertissement

Choisir avec soin la position d'installation et s'assurer que la puissance de sortie ne dépasse pas les limites en vigueur. La violation de cette règle peut conduire à de sérieuses pénalités fédérales.